

Outline:

- Excellent DC bias capability to handle high peak current.
- Flat wire winding, achieve a low D.C. Resistance.
- Inductance value and saturation current are less affected by temperature.
- Magnetic shielded structure: excellent resistance to electromagnetic interference.
- Compact design saves PCB mounting area.

Features:

- Core material: Composite.
- Core and winding loss:
See www.codaca.com/en/PowerInductorLossComparison
- Environmental: RoHS compliant, halogen free.
- Weight: 54.5g
- Moisture Sensitivity: Level (MSL) 1
(Unlimited floor life at <30°C / 85% relative humidity)
- Operating temperature range: -55°C ~ +150°C
(Including coil's own temperature rise).
- Storage temperature range: -40°C ~ +125°C

Application:

- PV inverter/Industrial control/New energy.
- DC /DC converters/Motherboards/Filter.
- High current switching regulators/Polyphase-switching regulators.

1 Product Dimensions (mm)

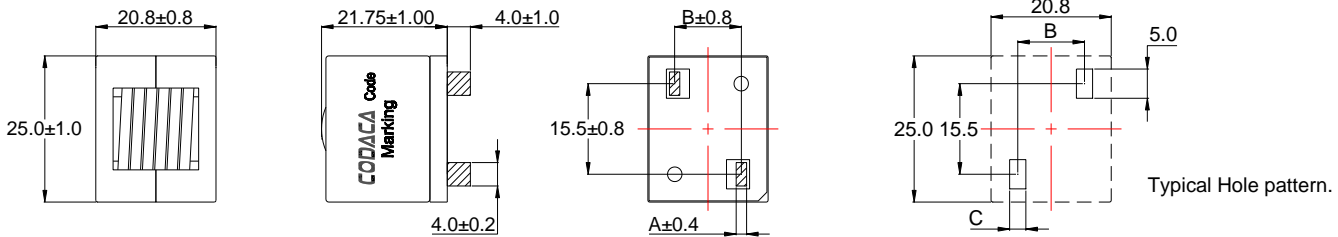

Part No.	1R2	2R2	3R3	4R7	6R8	8R2	100
Dimension A	3.20	2.50	2.00	1.80	1.60	1.40	1.10
Dimension B	10.80	10.85	11.35	11.55	12.30	12.50	10.85
Dimension C	4.20	3.50	3.00	2.80	2.60	2.40	2.00

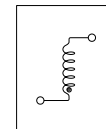

Schematic.

※ Date code will be changed by manufacture date.

2 Electrical Characteristics

Part No.	Inductance (μH) $\times 1$	D.C.R. (m Ω)		Isat (A) $\times 2$	I _{rms} (A) $\times 3$
		$\pm 20\%$	Typical		
CPRX2520L-1R2MC	1.20	0.25	0.30	150.0	80.0
CPRX2520L-2R2MC	2.20	0.38	0.42	110.0	75.0
CPRX2520L-3R3MC	3.30	0.63	0.70	90.0	65.0
CPRX2520L-4R7MC	4.70	0.80	0.95	70.0	62.0
CPRX2520L-6R8MC	6.80	1.00	1.15	60.0	53.0
CPRX2520L-8R2MC	8.20	1.35	1.50	50.0	47.0
CPRX2520L-100MC	10.0	1.85	2.00	45.0	44.0

All data is tested on 25°C ambient temperature

1. Inductance measure condition at 100kHz, 0.25V.
2. Isat: the actual value of DC current when the Inductance decrease 30% of its initial Value.
3. I_{rms}: The actual value of DC current when the Temperature rise is $\Delta T 50^\circ\text{C}$ ($T_a = 25^\circ\text{C}$)

3 How to Order

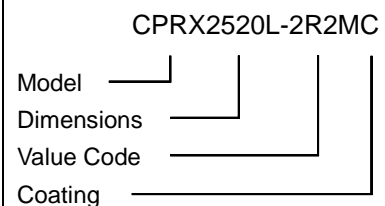

4 Saturation Current vs Temperature Rise Current Curve

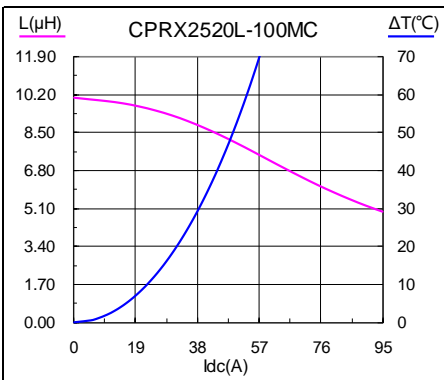
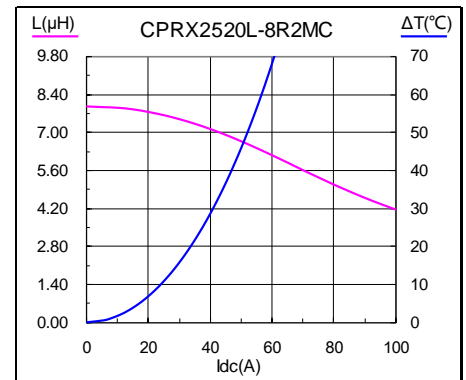
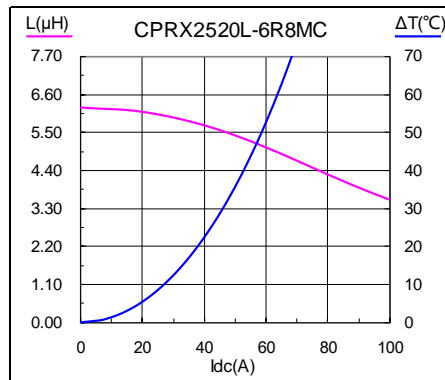
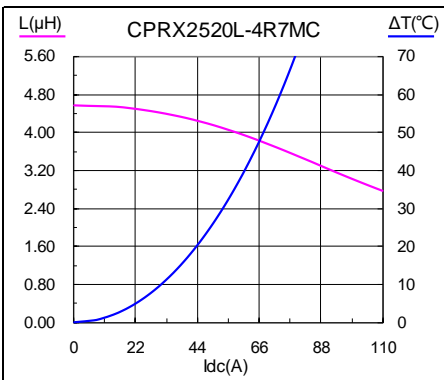
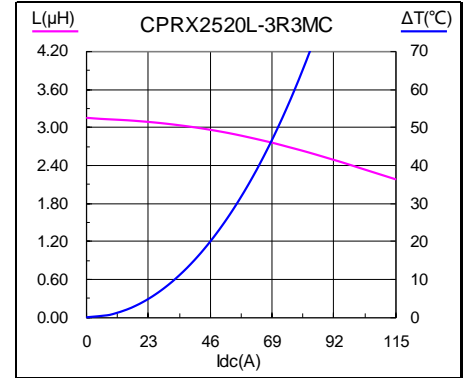
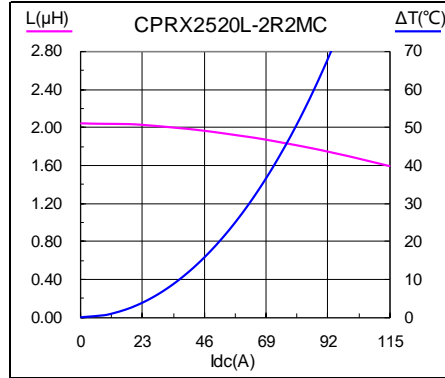
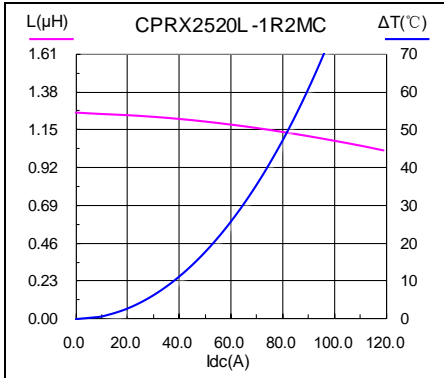

5 Packing Specification

5.1 Plastic Tray Dimensions (mm)

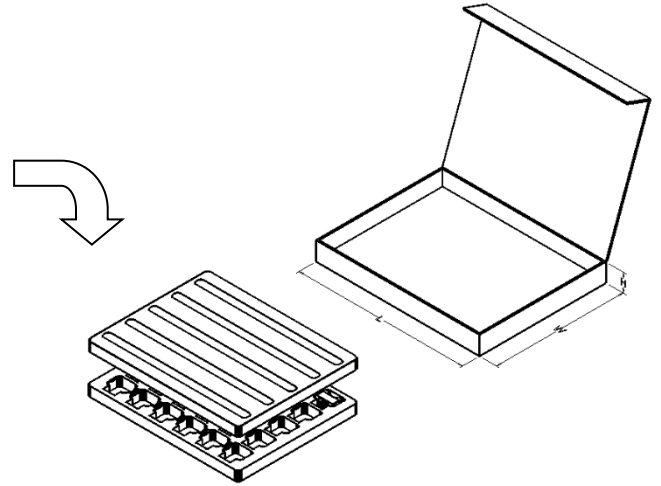
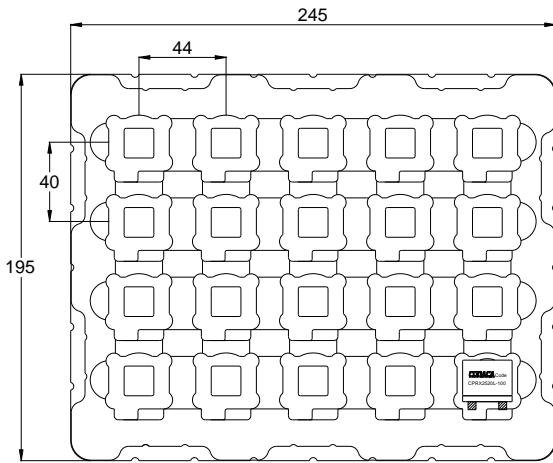

Packaging Unit (Pcs)	Material
20	APET

L typ	W typ	H typ	No. of Tray (Pcs)	Packaging Unit(Pcs)	Material
265	205	30	1	20	Paper

5.2 Packing(mm)

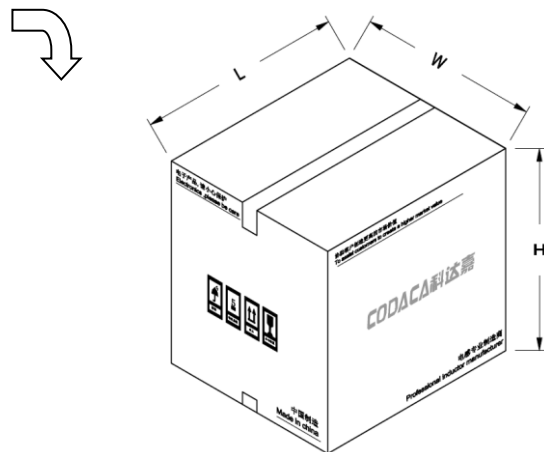
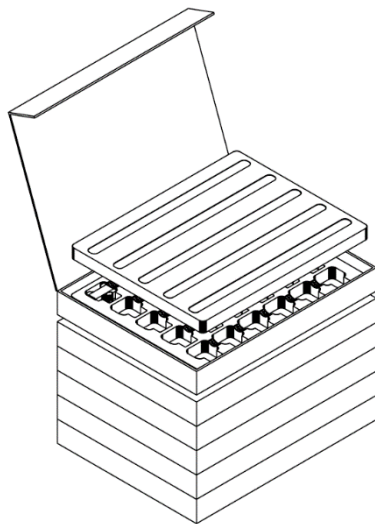

L typ	W typ	H typ	No. of Inner Carton	Packaging Unit(Pcs)	Material
275	232	261	7	140	Paper

深圳市科达嘉电子有限公司
SHENZHEN CODACA ELECTRONIC CO., LTD

TEL: +86 755 89585372 FAX: +86 755 89585280
http://www.codaca.com E-mail: info@codaca.com

This product is not authorized for use in any application related to safety.
Specification subject to change without notice. Please check website for latest information.

Revised: 07/14/2020

6 Notice of Use

- 6.1 Special remind:Circuit design, component placement, PCB size and thickness, cooling system and etc. all will affect the product temperature. Please verify the product temperature in the final application.
- 6.2 Product in packing storage condition:temperature 5 ~ 40°C, RH≤70%.
If taking out for use, the remaining products should be sealed in plastic bags and preserved in accordance with the above conditions, to avoid oxidation of terminals (electrodes), affecting soldering status.
- 6.3 A storage of Codaca Electronic products for longer than 12 months is not recommended, Within other effects, the terminals may suffer degradation, resulting in bad solderability. Therefore, all products shall be used within the period of 12 months based on the day of shipment.
- 6.4 Do not keep products in unsuitable storage conditions, such as areas susceptible to high temperatures, high humidity, dust or corrosion.
- 6.5 Always handle products with care.
- 6.6 Don't touch electrodes directly with bare hands as oil secretions may inhibit soldering.
Always ensure optimum conditions for soldering.
- 6.7 When this product will be used on a similar or new project to the original one,
sometimes it might be unable to satisfy the specifications due to different condition of usage.
- 6.8 This inductor itself does not have any protective function in abnormal condition, such as overload, short-circuit, open-circuit conditions, etc. Therefore, it shall be confirmed that there is no risk of smoke, fire, dielectric withstand voltage, insulation resistance, etc., or use in abnormal conditions protective devices or protection circuit in the end product.
- 6.9 Hi-Pot test with higher voltage than spec value will damage insulating material and shorten its life.
- 6.10 If using in potting compound, the magnet wire coating might be damaged, please consult with us.
- 6.11 Refrain from rinsing coils. If necessary, please consult with us.
- * 6.12 Codaca Electronic products without "V" prefix are qualified for industrial product requirement , and with "V" prefix are qualified for AEC-Q200, but it doesn't mean that Codaca Electronic products can absolutely meet specific industry norms and quality test standards in automotive electronics or more strict application fields . Codaca Electronic will be exempted from being responsible for the consequences of using Codaca products in automotive electronic or higher application field related to safety when without being aware of it.