

Products Summary

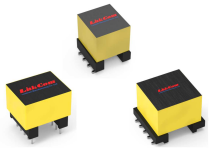

Telecom

Being a magnetic component manufacturing and telecom industry leader, LinkCom continue to grow and develop with integrated circuits vendors. We provide optimized solution for size, performance, and costs including ADSL, ADSL2+, VDSL, VDSL2, G.fast, Smart DAA etc.

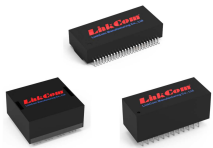

LAN Transformers

LinkCom's LAN transformers, modules, filters, are full compliance with IEEE802.3 and ANSI X3.263 standards. We offer both PoE, PoE+, and PoE++ products.

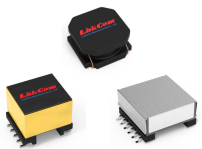

Power Magnetics

LinkCom provides customized switching power transformers, inductors, PFC Inductor, Line filter, current sense transformer, gate drive transformers and so on.

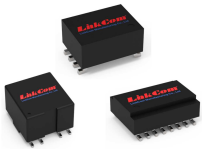

PLC Transformers

LinkCom works with chip vendors for HomePlug®, G.hn, G3-PLC...etc.

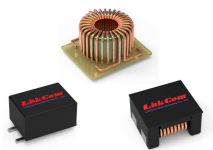

EMI/RFI Filters

LinkCom provides common mode, differential mode and also dual mode noise suppression. Commonly used in automotive, telecom, industrial...etc.



RF Transformers

LinkCom has plenty of balun transformers for impedance matching which are also suitable for DOCSIS3.0, DOCSIS3.1 and further.

Index

DSL Application	1
Broadcom.....	1
Intel.....	5
ECONET.....	6
Realtek.....	7
Metanoia.....	9
Common Mode Filters	10
HD9055 Series.....	10
LCMF7060 Series.....	14
PLC Applications	17
G.hn Applications - Maxlinear.....	17
HomePlug® Applications - Qualcomm.....	19
Voice band Applications	21
Microsemi.....	21
Silicon Labs.....	22
LAN Applications	24
2.5/5G BASE-T Magnetic Module.....	24
10/100/1000 BASE-T Magnetic Module.....	25
10/100 BASE-T Magnetic Module.....	27
PoE Applications	28
Texas Instruments.....	28
Silicon Labs.....	31
Customized.....	31
Gate-Drive Transformers	35
Current Sense Transformers	36
EE5 Series.....	36
EF12 Series.....	37
SMD Power Inductors	38

DSL Applications - Broadcom

IC Number	LinkCom Part Number	Application	Location	Annex	6KV Surge	Schematic	Dimension
BCM63168/148/168	LAL0665-53	ADSL	CPE	-	No	A	#1
BCM63168/148/168	LAL2020-51	ADSL	CPE	-	No	A	#2
BCM96368	LAL0560-50	VDSL2	CPE	A	No	A	#1
BCM96368	LAL2620-50	VDSL2	CPE	A	Yes	A	#2
BCM63138/148/168	LAL0562-50	VDSL2	CPE	A	No	B	#3
BCM63138/148/168	LAL0562-60	VDSL2	CPE	A	Yes	B	#3
BCM63138/148/168	LAL0573-50	VDSL2	CPE	B	No	B	#3
BCM63138/148/168	LAL0573-60	VDSL2	CPE	B	Yes	B	#3
BCM63138/148/168	LAL0575-50	VDSL2	CPE	B/J	No	B	#3
BCM63138/148/168	LAL0575-60	VDSL2	CPE	B/J	Yes	B	#3
BCM63138	LAL1038-60	VDSL2	CPE	C	Yes	C	#5
BCM63138/148	LAL1275-50	VDSL2 RNC	CPE	-	No	E	#5
BCM63138/148	LAL1276-50	VDSL2 RNC	CPE	-	No	E	#5
BCM63381	LAL0572-50	VDSL2	CPE	A	No	B	#3
BCM63381	LAL0572-60	VDSL2	CPE	A	Yes	B	#3
BCM63381	LAL0576-50	VDSL2	CPE	B/J	No	B	#3
BCM63381	LAL0576-60	VDSL2	CPE	B/J	Yes	B	#3
BCM63138	LGT1502-50	G.fast	CPE	-	No	C	#6
BCM63138	LGT1502-60	G.fast	CPE	-	Yes	C	#6
BCM6524x	LGT0500-50	G.fast	CO	-	No	C	#6
BCM6524x	LGT1500-50	G.fast	CO	-	No	C	#6
BCM63138	LGT1502-50	G.fast	CPE	-	No	C	#6
BCM63138	LGT1502-60	G.fast	CPE	-	Yes	C	#6
BCM63158	LGT0105-60	Balun	CPE	-	Yes	F	#7
BCM63158	LGT2507-50	G.fast	CPE	-	No	D	#4
BCM63158	LGT0502-50	G.fast RNC	CPE	-	No	C	#6
BCM63158	LGT1512-60	G.fast	CPE	-	Yes	C	#6

DSL Applications - Broadcom

Schematics:

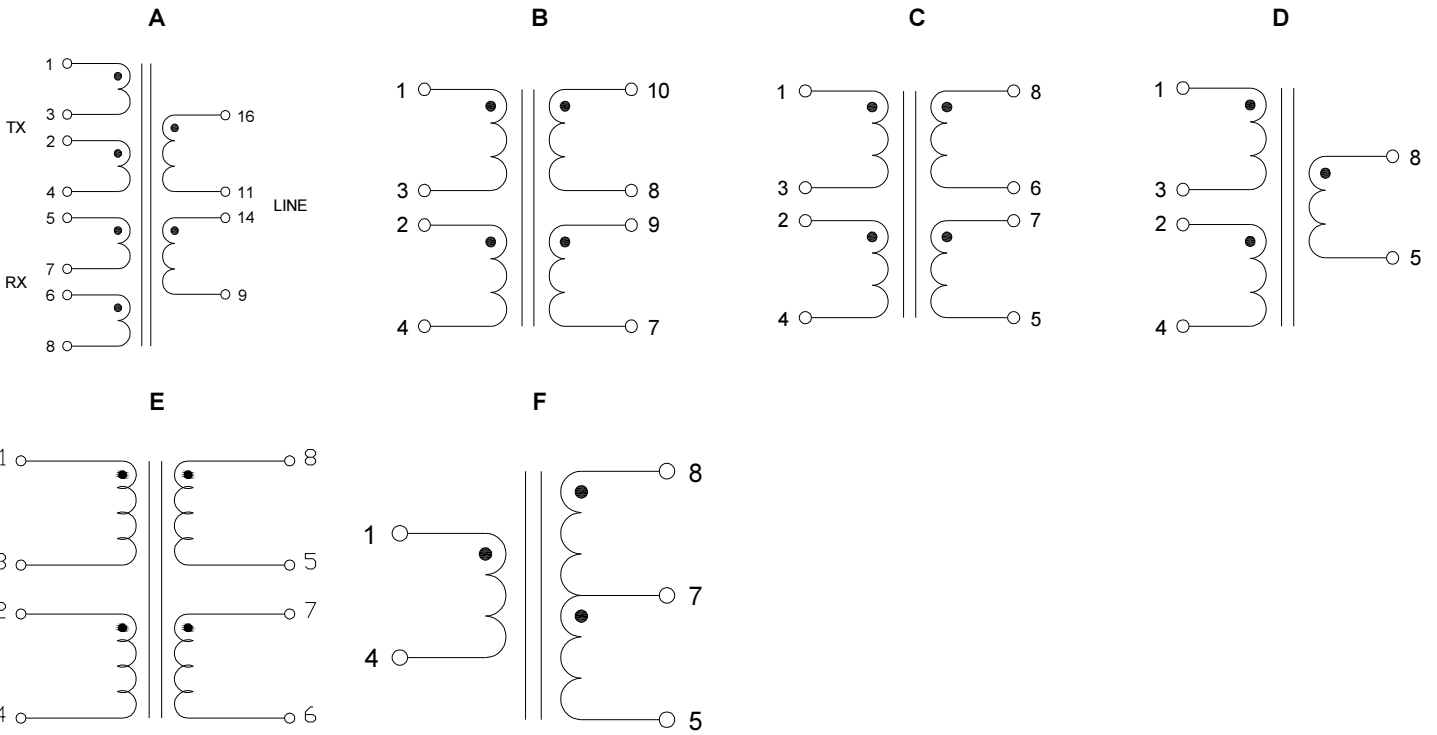

DSL Applications - Broadcom

Dimension: (Units: $\frac{\text{Inches}}{\text{mm}}$)

#1(EP-13)

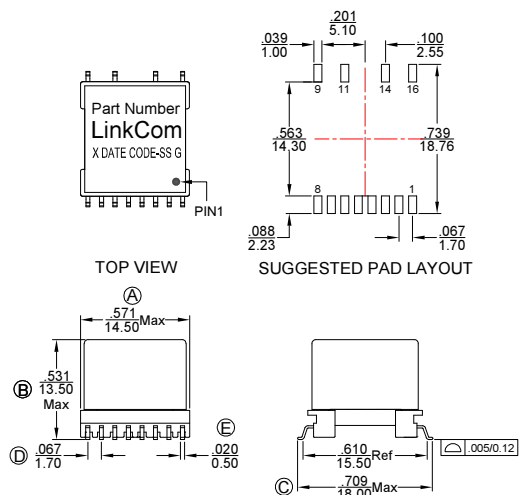

#2(EP-13-L)

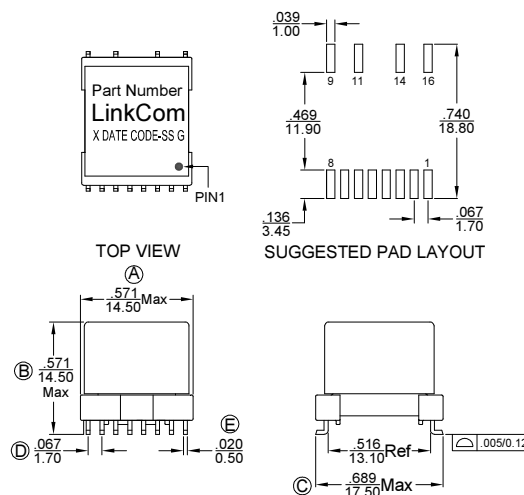

#3(EP-13)

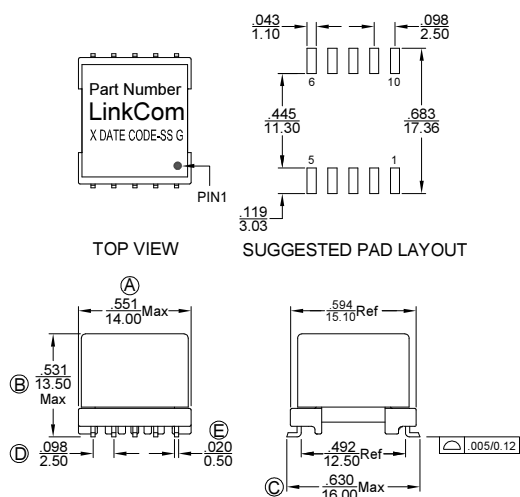

#4(EP-7)

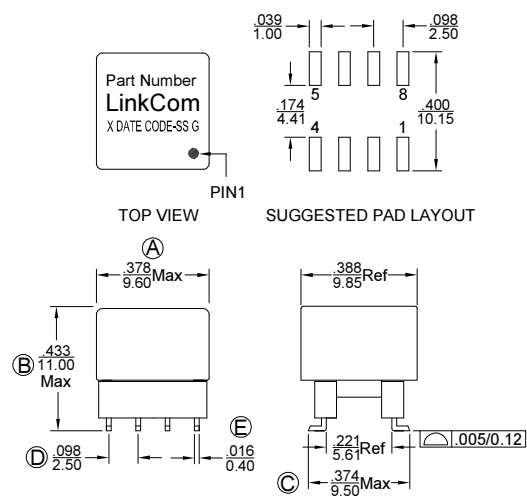

DSL Applications - Broadcom

#5(EP-7)

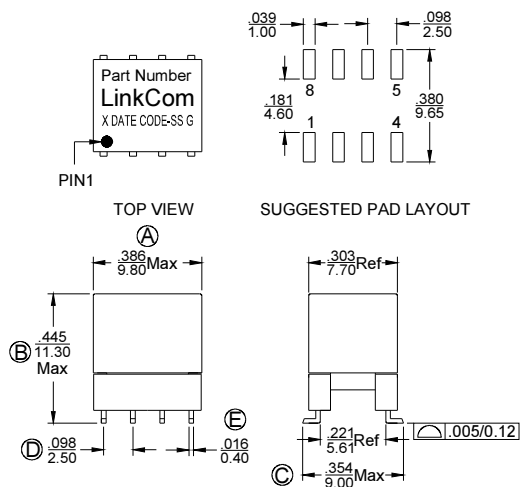

#6(EP-5.5)

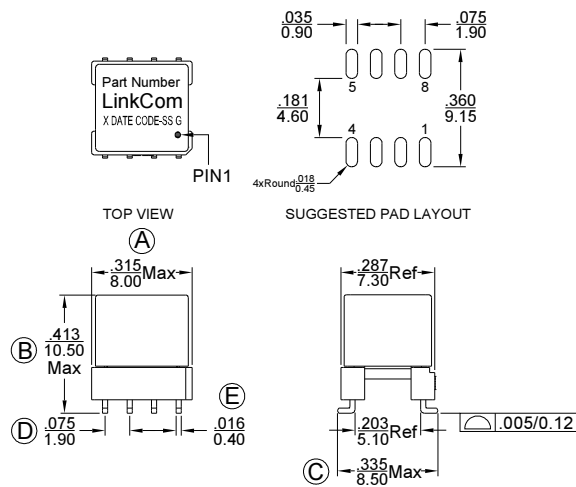

#7(HD-8P-H55)

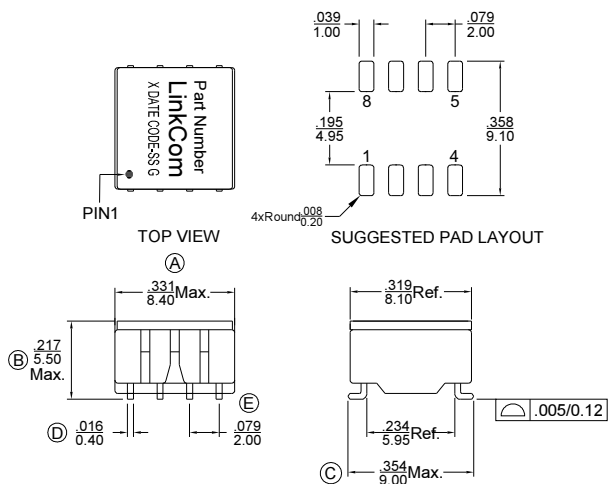

DSL Applications - Intel

IC Number	LinkCom Part Number	Application	Location	Annex	6KV Surge	Schematic	Dimension
VR9/VRX2xx/ VRX318	LAL0520-50	VDSL2	CPE	A	No	A	#1
VR9/VRX2xx/ VRX318	LAL0530-50	VDSL2	CPE	B	No	A	#1
AR10, ARX300	LAL2688-50	ADSL2+	CPE	A/B/J	No	B	#2
VRX518	LAL0580-63	VDSL2	CPE	A	Yes	C	#2

Schematics:

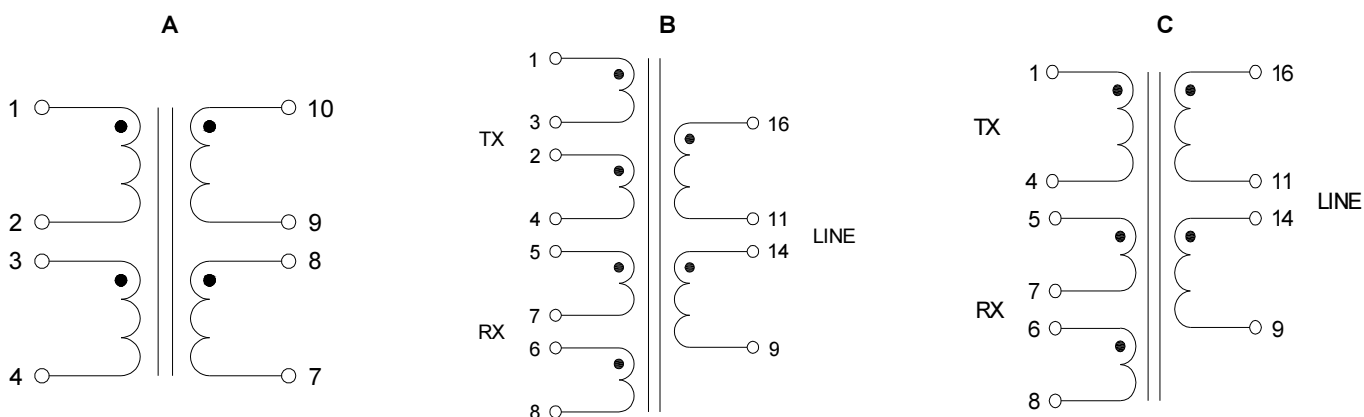

Dimension: (Units: $\frac{\text{Inches}}{\text{mm}}$)

#1(EP-13)

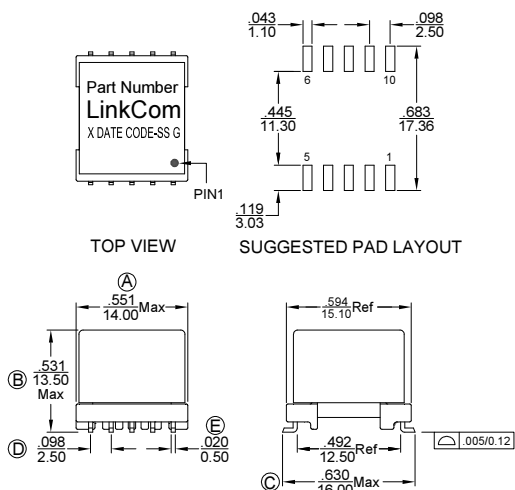

#2(EP-13)

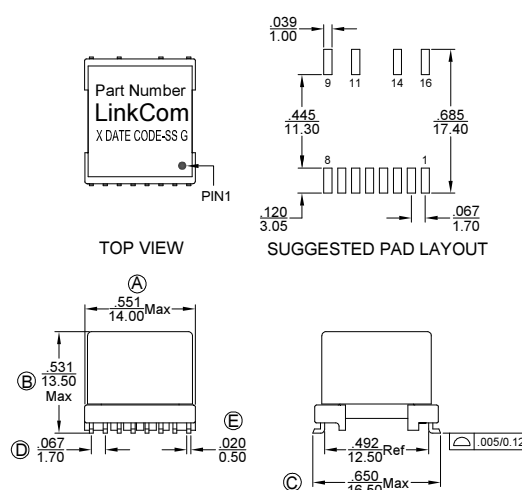

DSL Applications - ECONET

IC Number	LinkCom Part Number	Application	Location	Annex	6KV Surge	Schematic/ Dimension	Package
TC3085	LAL2009-51	ADSL2+	CPE	A	No	A	#1
RT63087	LAL2209-50	ADSL2+	CPE	A	No	A	#1
MT7555 EN7556	LAL2522-52	VDSL2	CPE	A	No	B	#2

Schematics:



Dimension: (Units: $\frac{\text{Inches}}{\text{mm}}$)

#1(EP-13)

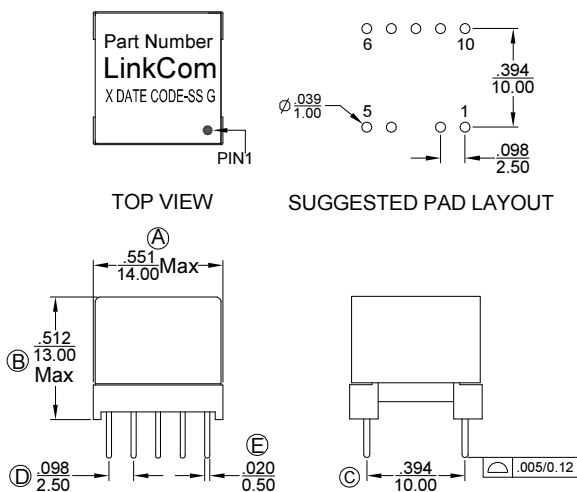

#2(EP-13)

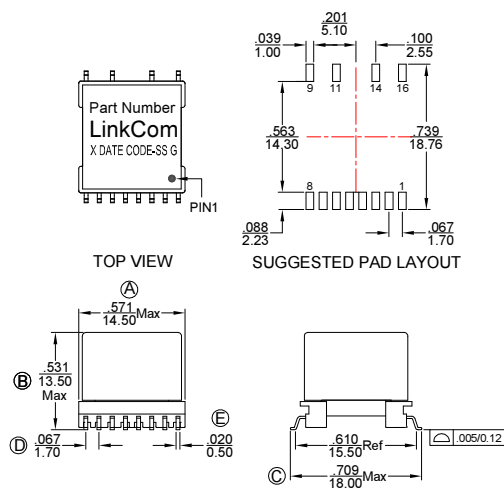

DSL Applications - Realtek

IC Number	LinkCom Part Number	Application	Location	Annex	6KV Surge	Schematic	Dimension
RTL-8271B/8186/8676	LAL2188-50	ADSL2+	CPE	A	No	A	#1
RTL-8685	LAL0525-51	VDSL2	CPE	A	No	B	#2
RL8685SF/PB/P	LAL0581-60	VDSL2	CPE	A	Yes	C	#3
RL8685SF/PB/P	LAL0582-60	VDSL2	CPE	A	Yes	C	#3
New design	LGT1702-61	G.Fast	CPE	A	No	D	#4

Schematics:

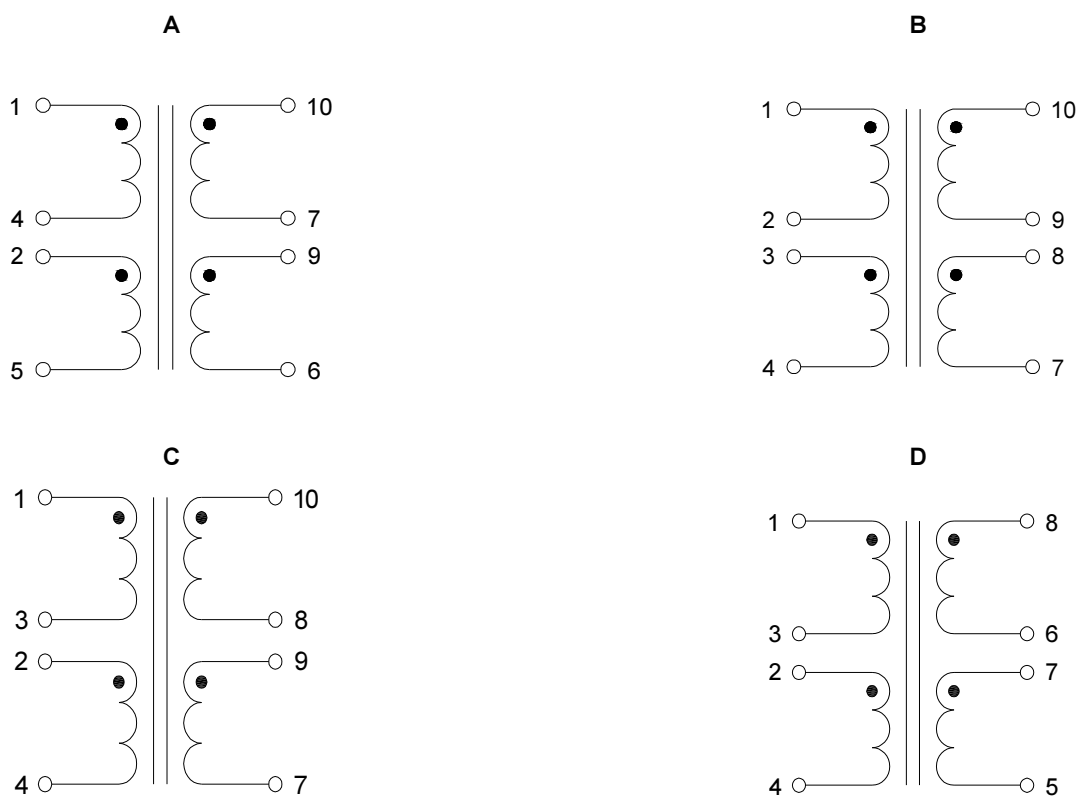

DSL Applications - Realtek

Dimension: (Units: $\frac{\text{Inches}}{\text{mm}}$)

#1(EP-13)

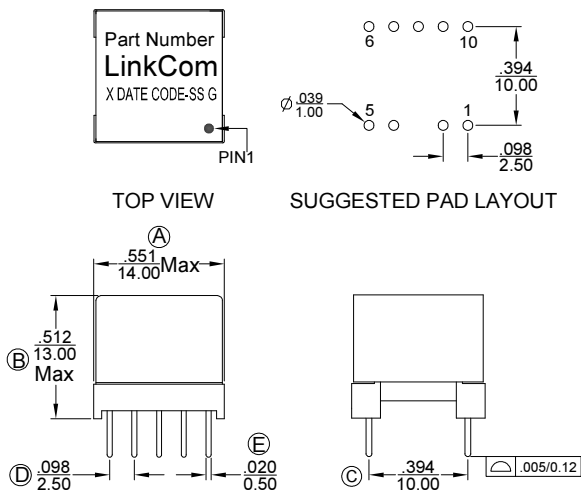

#2(EP-13)

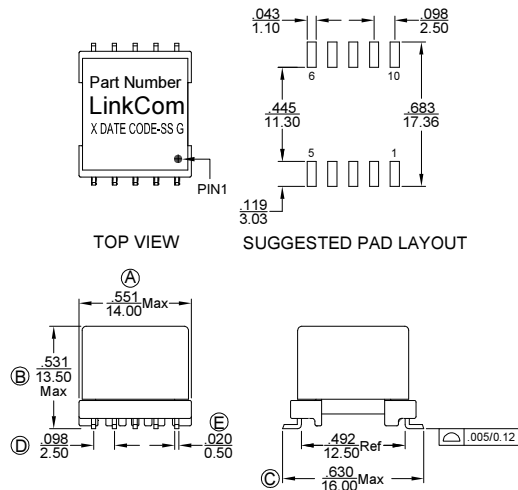

#3(EP-13)

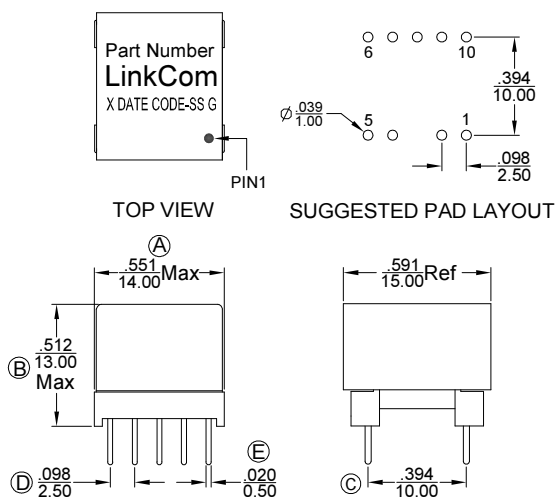

#4(EP-5.5)

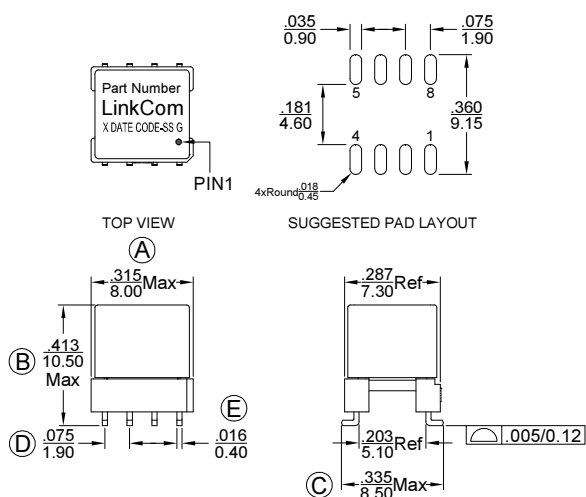

DSL Applications - Metanoia

IC Number	LinkCom Part Number	Application	Location	Annex	6KV Surge	Schematic	Dimension
MT-V5311	LAL1037-61	ADSL2+/VDSL2	CO/CPE		Yes	A	#1

Schematics:

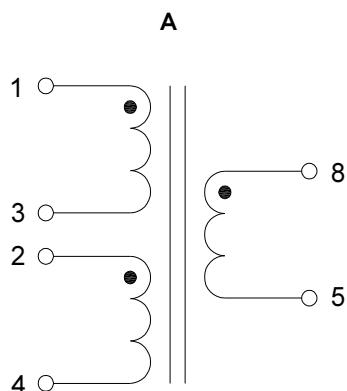

Dimension: (Units: $\frac{\text{Inches}}{\text{mm}}$)

#1(EP-7)

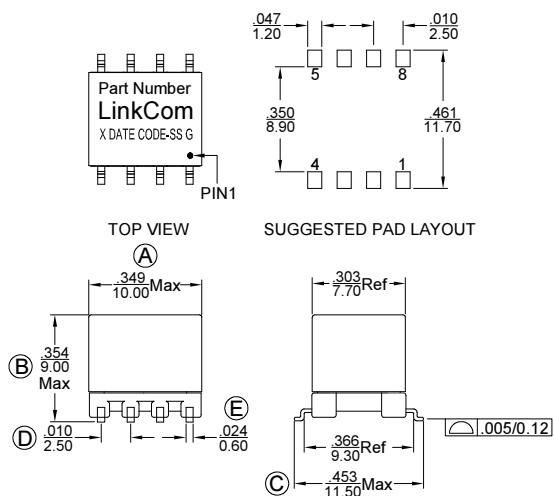



Common Mode Filters – HD9055 Series

- RoHS Compliant
- Operating Temperature -40°C to +85°C

Electrical Specifications @25°C

Inductance (mH)	D.C.R. (mΩ, ref.)	Hi-POT (VAC/2s)	LinkCom Part Number	Winding Type
0.0050	23	500	LTC0290-50	Bifilar
0.0110	110	500	LTC0287-50	Bifilar
0.0138	28	500	LTC0567-50	Sectional
0.0250	68	500	LTC0291-50	Bifilar
0.0510	180	500	LTC0292-50	Bifilar
0.0510	90	500	LTC0551-50	Sectional
0.1000	190	500	LTC0293-50	Bifilar
0.4700	300	500	LTC0283-50	Bifilar
0.5000	150	500	LTC0370-50	Bifilar
0.6800	95	500	LTC0581-50	Bifilar
1.0000	120	500	LTC0285-50	Bifilar
2.2000	350	500	LTC0271-50	Bifilar
4.7000	650	500	LLF0097-50	Bifilar

Dimensions

(Units: $\frac{\text{Inches}}{\text{mm}}$, Unless otherwise specified, all tolerances are $\pm\frac{.010}{0.25}$)

Schematic

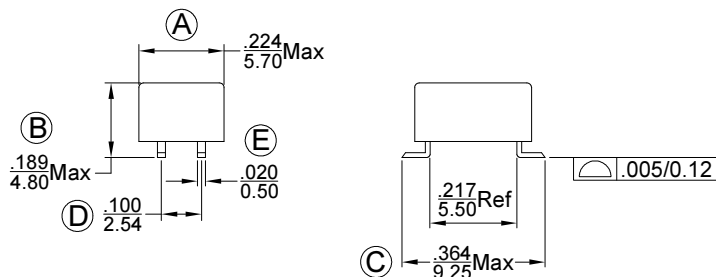
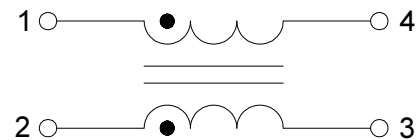
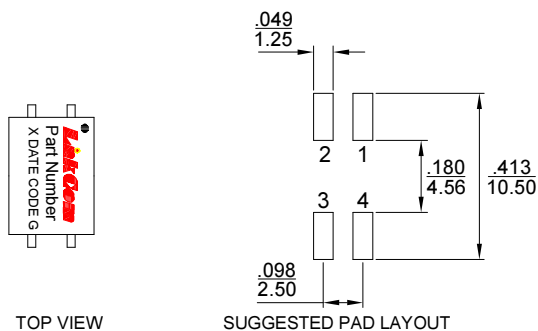



Common Mode Filters – HD9055 Series

Insertion loss

- Common mode
- - - Differential mode

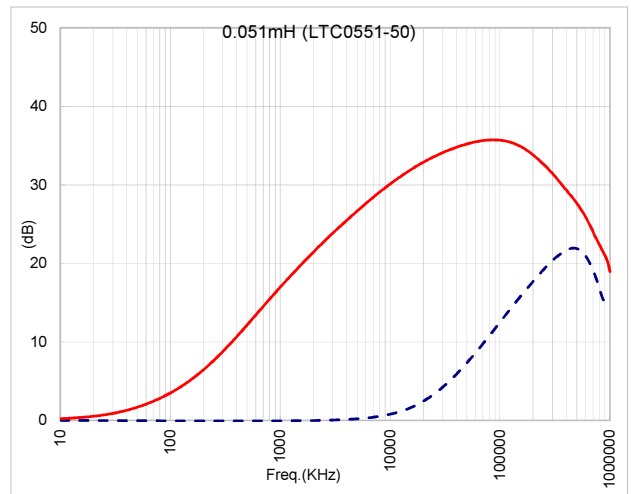
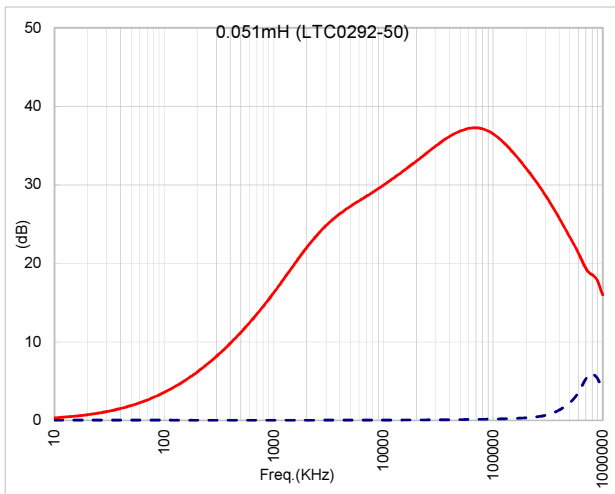
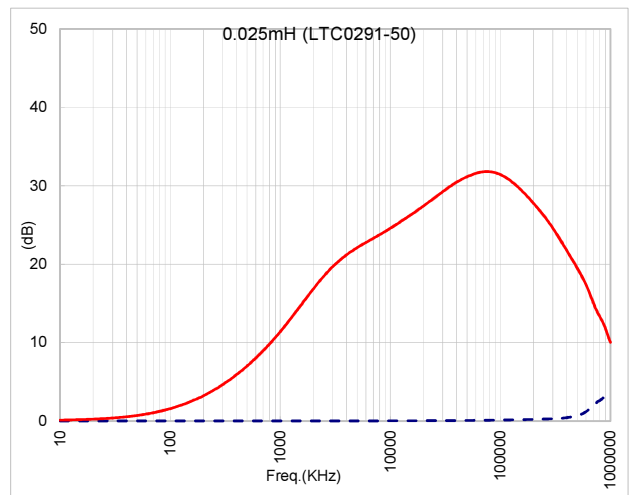
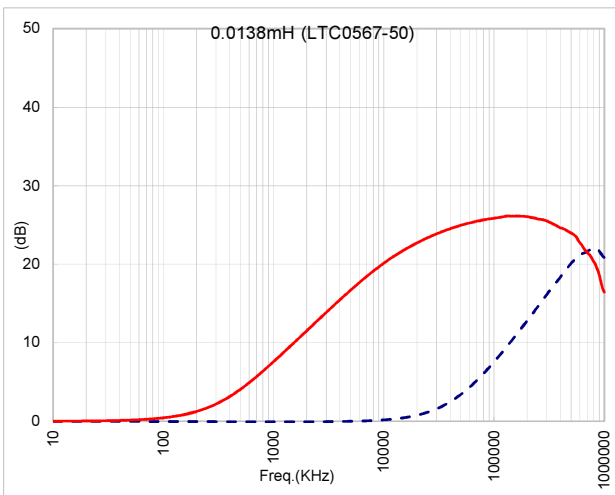
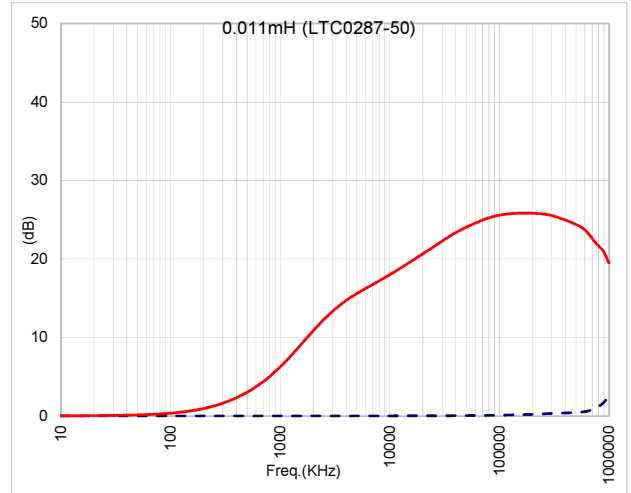
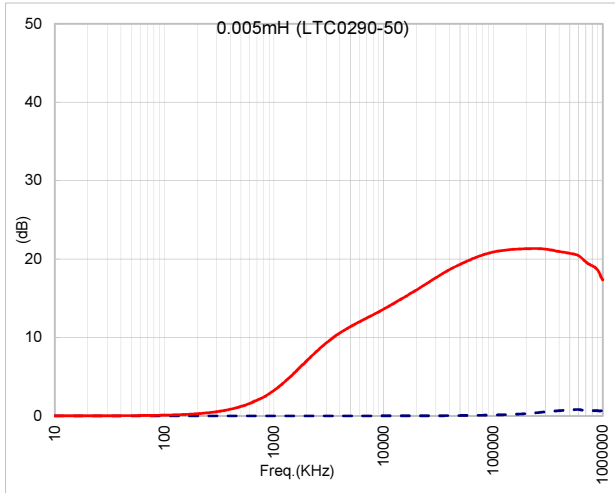



Common Mode Filters – HD9055 Series

Insertion loss

— Common mode
- - - Differential mode

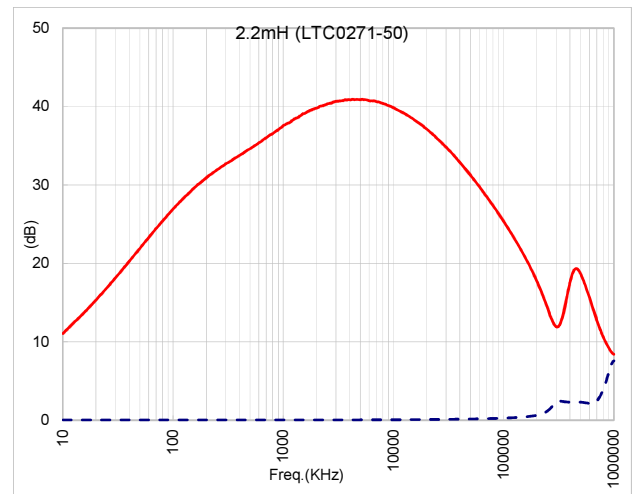
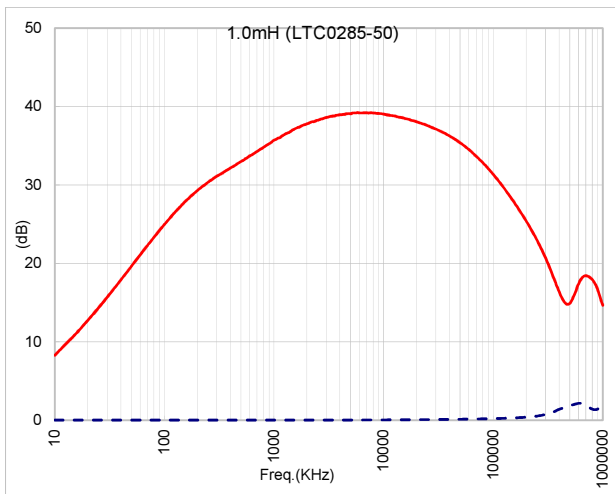
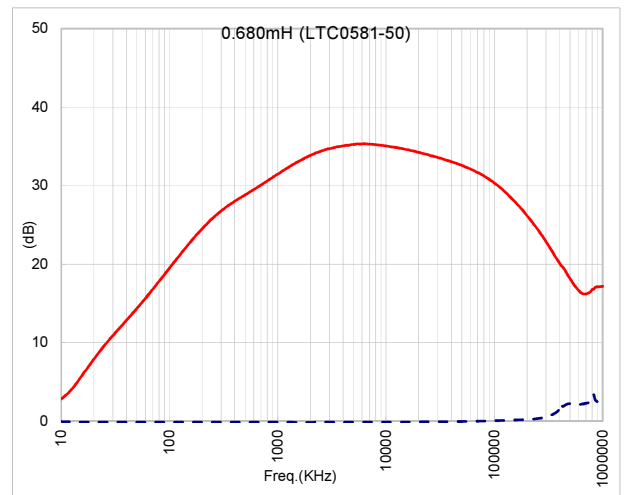
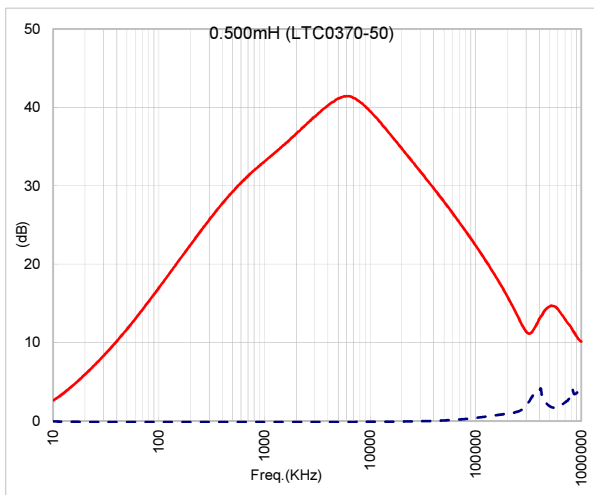
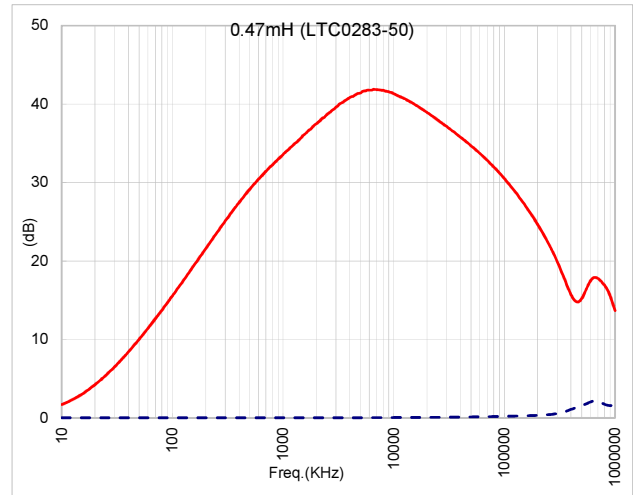
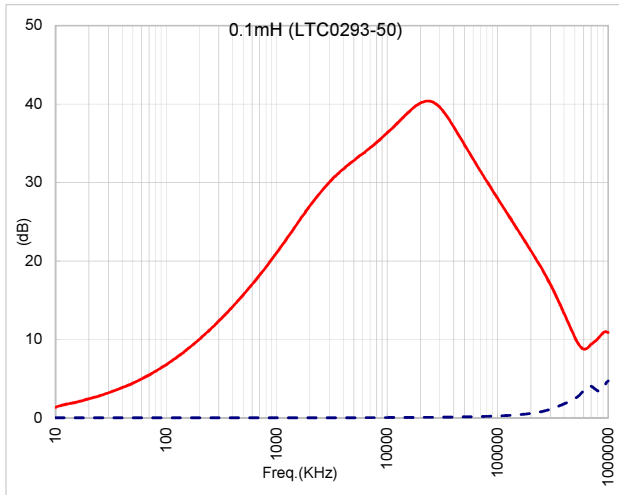



Common Mode Filters – HD9055 Series

Insertion loss

- Common mode
- - - Differential mode

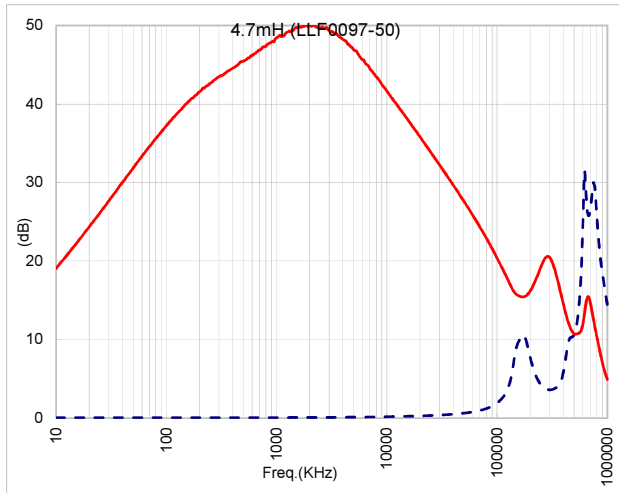

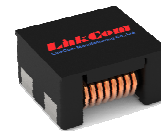

Common Mode Filters – LCMF7060 Series

Features

- Designed for noise suppression at DC power lines.
- Low profile (H = 3.8mm).
- Small size.
- High rated current.
- Operating temperature: -40°C ~ 85°C.

Applications

- Power line equipment like DC-DC converters, battery chargers.
- Portable equipment like PDAs, laptops, printers.

Product Identification

LCMF 7060 P1 - 800 - 2P
1 2 3 4 5

1. Series : LCMF= LinkCom Common Mode Filter
2. Dimension Code: 7.0mm x 6.0mm x 3.8mm
3. Shielding Type/Application P1=Power
4. Impedance Value 80Ω
5. Number of lines 2P=2-line

Dimension(mm)

(Units: $\frac{\text{mm}}{\text{Inches}}$, Unless otherwise specified, all tolerances are $\pm \frac{0.25}{[.010]}$)

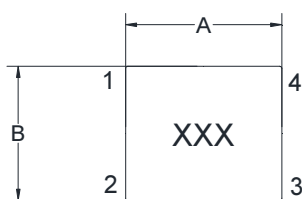

TOP VIEW

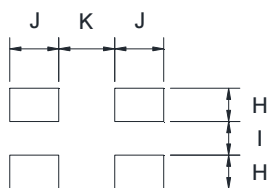

SUGGESTED PAD LAYOUT

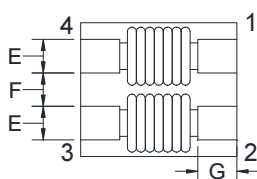

BOTTOM VIEW

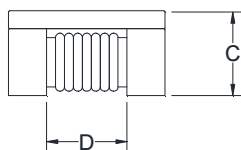

Schematic

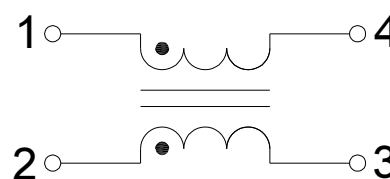

Mark

XXX---- Impedance

A	$\frac{7.00 \pm 0.50}{[.276 \pm .019]}$	G	$\frac{1.70 \pm 0.20}{[.067 \pm .008]}$
B	$\frac{6.00 \pm 0.50}{[.236 \pm .019]}$	H	$\frac{1.50}{[.059]}$
C	$\frac{3.80 \text{ MAX}}{[.149 \text{ MAX}]}$	I	$\frac{1.50}{[.059]}$
D	$\frac{3.50 \text{ Typ}}{[.138 \text{ Typ.]}$	J	$\frac{2.20}{[.087]}$
E	$\frac{1.50 \pm 0.20}{[.059 \pm .008]}$	K	$\frac{2.50}{[.098]}$
F	$\frac{1.50 \pm 0.20}{[.059 \pm .008]}$		



Common Mode Filters – LCMF7060 Series

Electrical Characteristics

Part Number	Z(Ω) at 100MHz		D.C. Resistance (mΩ) Max.	Rated Current (A) Max.	Rated Voltage Vdc (V)	Insulation Resistance (MΩ) Min.	Mark
	Min.	Typ.					
LCMF7060P1-400-2P	40	70	5	15	80	10	400
LCMF7060P1-101-2P	100	140	10	9	80	10	101
LCMF7060P1-301-2P	225	300	10	5	80	10	301
LCMF7060P1-501-2P	275	350	10	5	80	10	501
LCMF7060P1-601-2P	500	700	15	4	80	10	601
LCMF7060P1-701-2P	500	700	15	4	80	10	701
LCMF7060P1-102-2P	800	1020	17	3	80	10	102
LCMF7060P1-132-2P	910	1300	21	2.5	80	10	132
LCMF7060P1-272-2P	2000	2700	63	1	80	10	272
LCMF7060P1-302-2P	2500	3000	75	0.9	80	10	302

Impedance

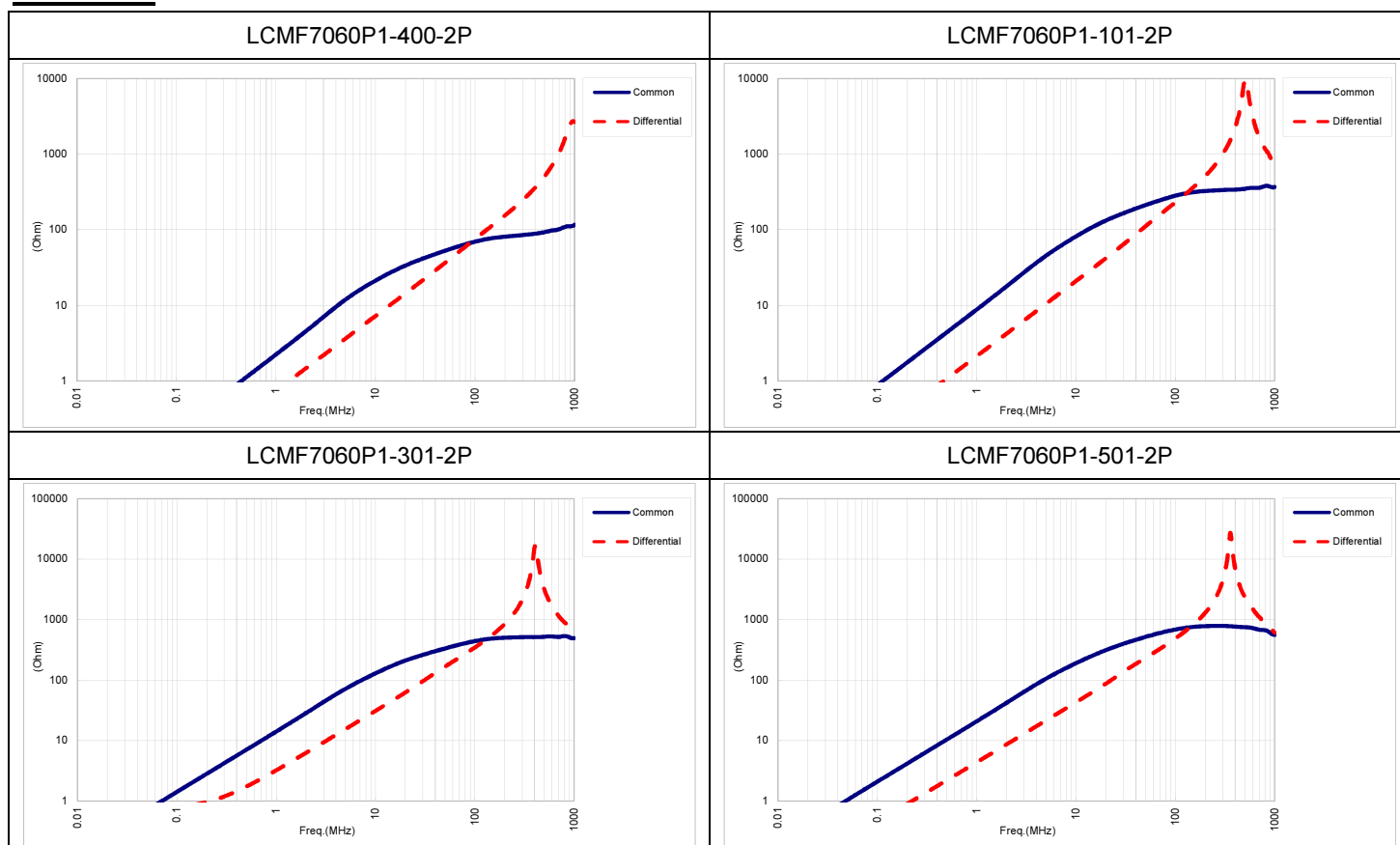

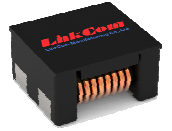

Common Mode Filters – LCMF7060 Series

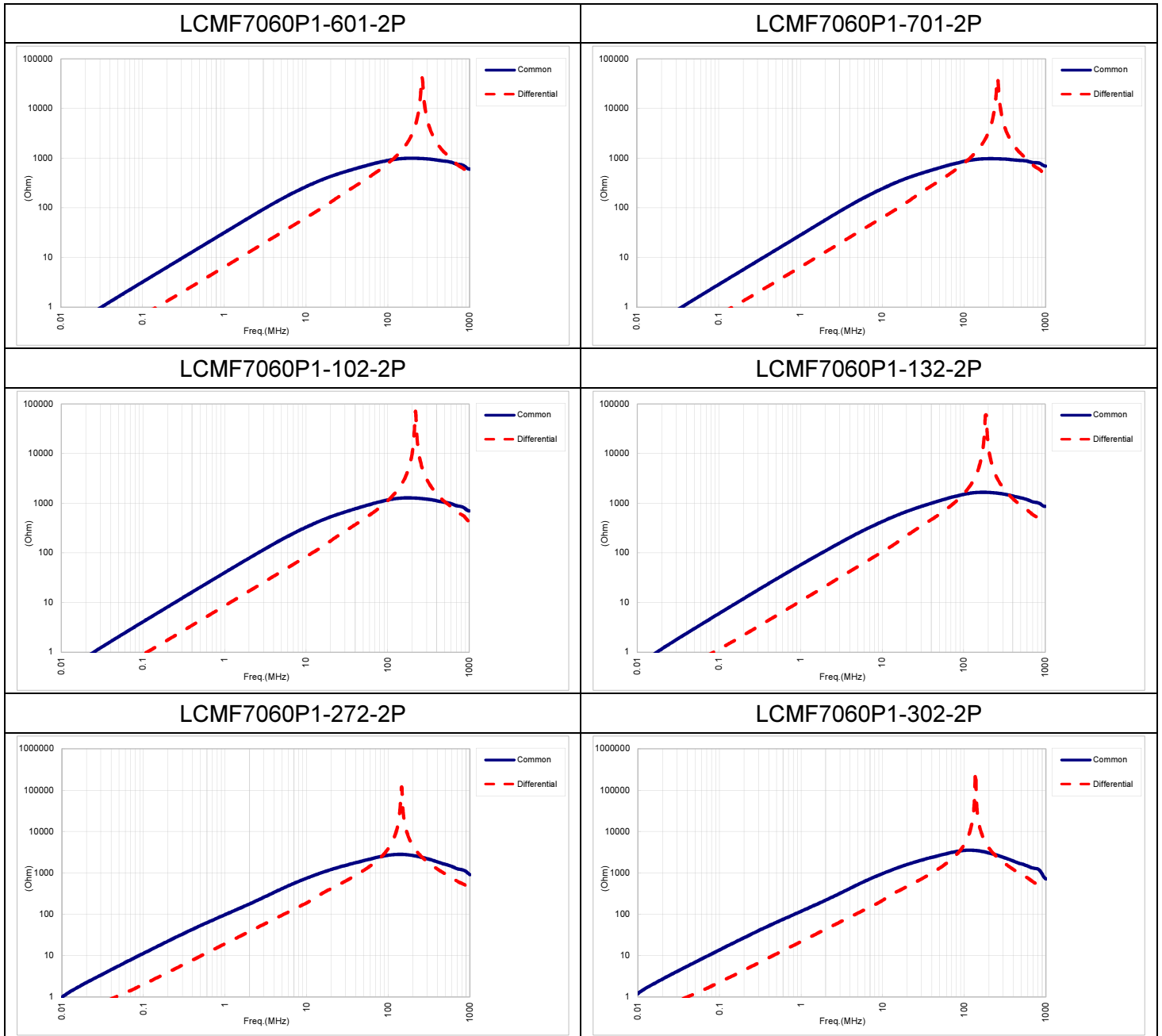

G.hn Applications - Maxlinear

IC Number	LinkCom Part Number	Application	Specification	Schematic	Dimension
88LX5153(DSP) 88LX2730(AFE)	LTC0331-51	Wave-2 chipset / 200 MHz Coaxial/ phone line	15μH Min. 2CT(line):2(Rx):1(Tx)	A	#1
88LX5152(DSP) 88LX2720(AFE)	LTC0353-51	DW920 design / MIMO Wave-2 chipset	54μH Min. 3(line):3(Rx):1(Tx)	B	#2
88LX5152(DSP) 88LX2720(AFE)	LTC0502-50	DW920 design / SISO Wave-2 chipset	54μH Min. 3(line):3(Rx):1(Tx)	C	#1
88LX5152(DSP) 88LX2720(AFE)	LLF0131-51	CM choke for G.hn AC /DC power supply Coaxial/ phone line	47mH Min. 1:1	D	#3
88LX5152(DSP) 88LX2720(AFE)	LLF0132-50	CM choke for G.hn AC /DC power supply Coaxial/ phone line	47mH Min. 1:1	D	#4

Schematics:

A

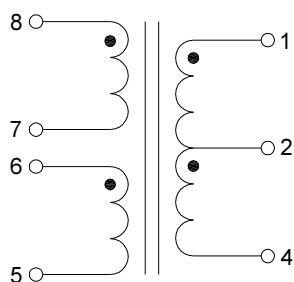

B

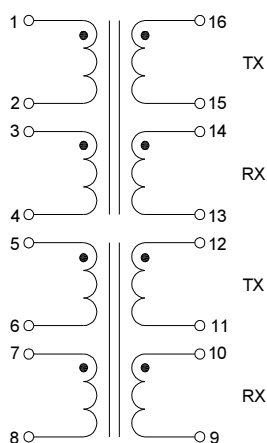

C

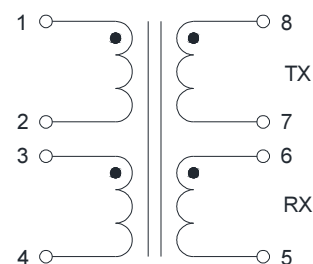

D

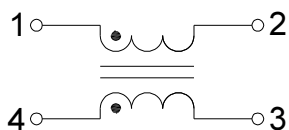

G.hn Applications - Maxlinear

Dimension: (Units: $\frac{\text{Inches}}{\text{mm}}$)

#1

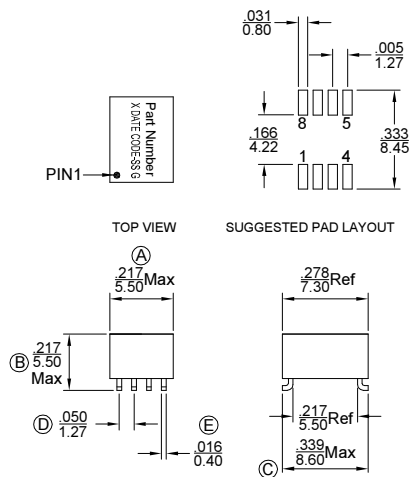

#2

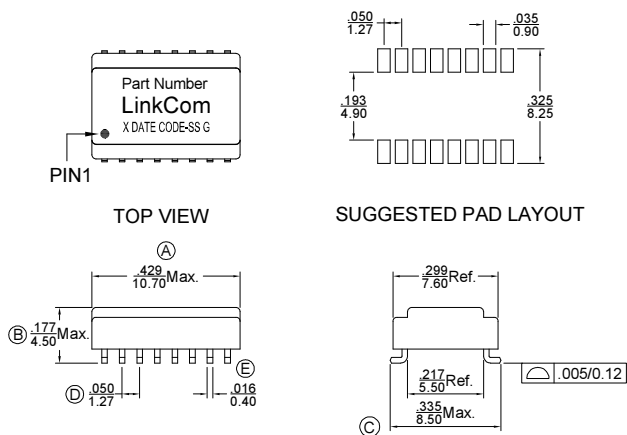

#3

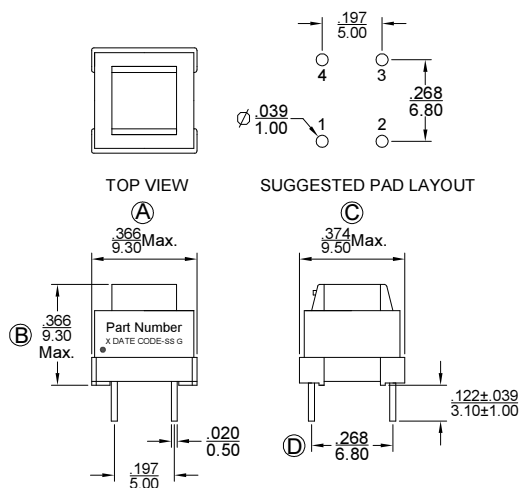

#4

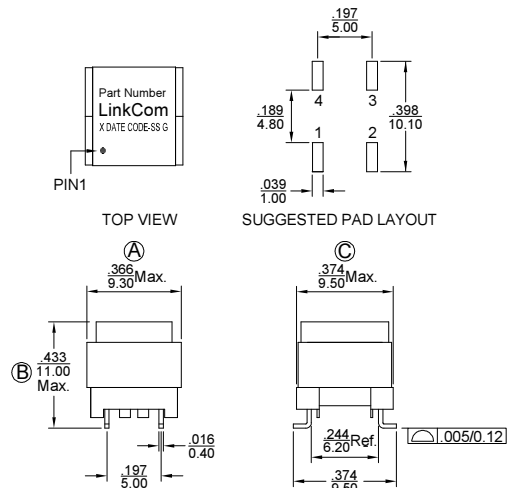

HomePlug[®] - Applications Qualcomm

IC Number	LinkCom Part Number	Application	Specification	Schematic	Dimension
QCA7005	LTC0388-50	Coupling XFMR Home Plug Green PHY™ Electric Vehicle Charging	10uH Min. 1:1	A	#1
QCA7005	LTC0389-50	Coupling XFMR Home Plug Green PHY™ Electric Vehicle Charging	10uH Min. 1:1	B	#1
QCA7005	LTC0508-50	Coupling XFMR Home Plug Green PHY™ Reinforced insulation	10uH min. 1:1	B	#2
QCA75X0	LLF0129-50	Coupling XFMR Home Plug AV2	20mH Min. 1:1	C	#3
QCA75X0	LLF0130-50	Coupling XFMR Home Plug AV2	20mH, Min. 1:1	D	#5
QCA75X0	LLF0133-50	Coupling XFMR Home Plug AV2	20mH, Min.; 1:1	C	#4

Schematics:

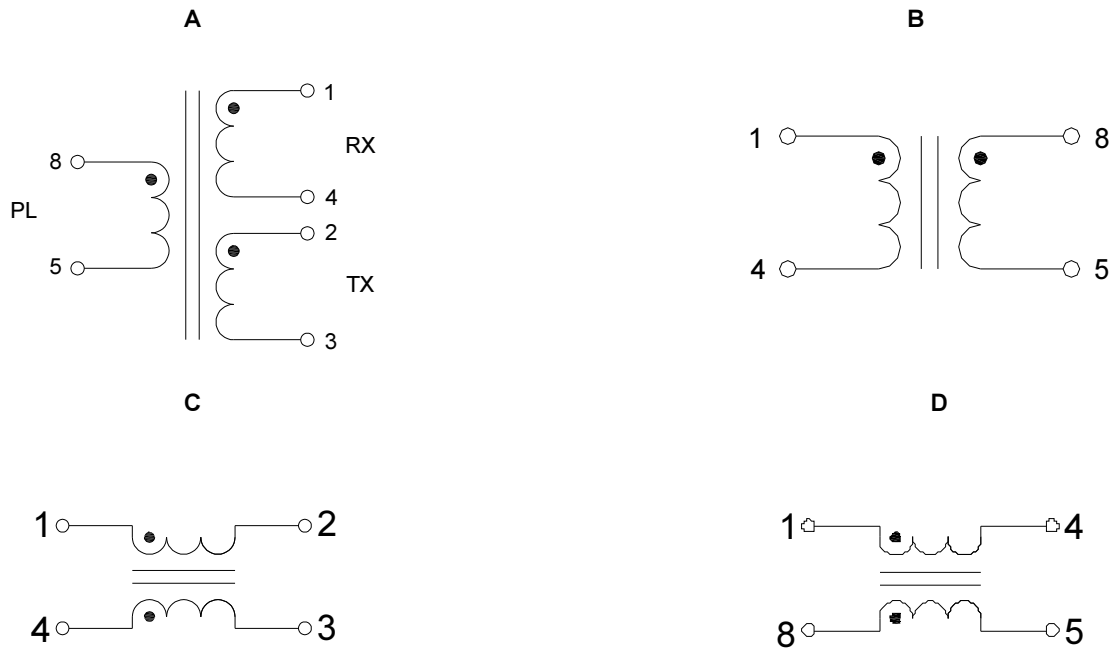

HomePlug[®] - Applications Qualcomm

Dimension: (Units: $\frac{\text{Inches}}{\text{mm}}$)

#1

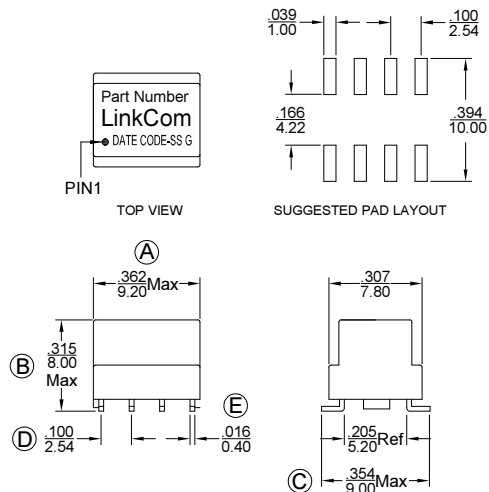

#2

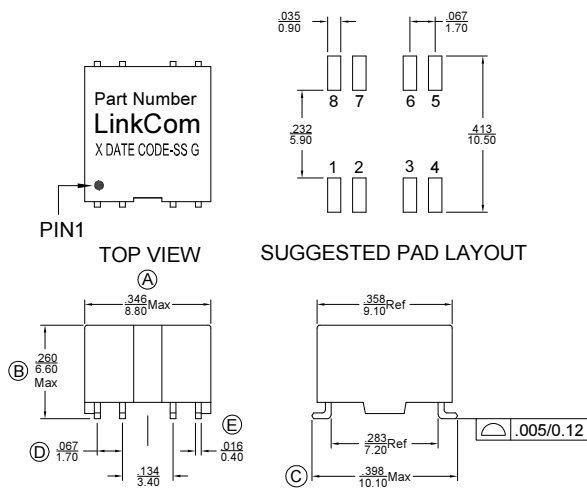

#3

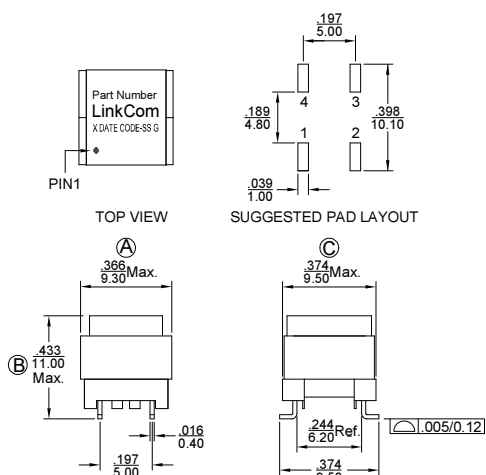

#4

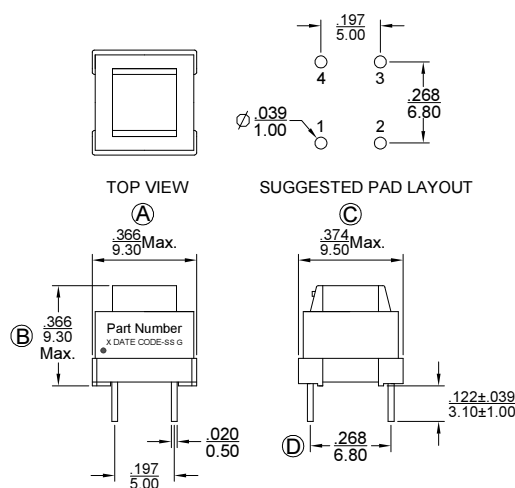

#5

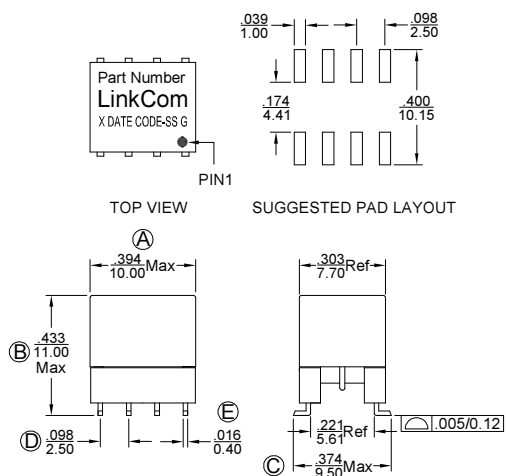

Voice band Applications - Microsemi

IC Number	LinkCom Part Number	Inductance (uH)	Turn Ratio	Schematic	Dimension
Le9632, Le9641, Le9643, Le9651, Le9652, Le9653,	LDT0898-50	2.0	5-8:3-2=10:1 7-8:3-2=3.5:1	A	#1
Le9672, ZL88701, ZL88702	LDT0993-52	2.0	5-8:3-2=10:1	B	#1

Schematics:

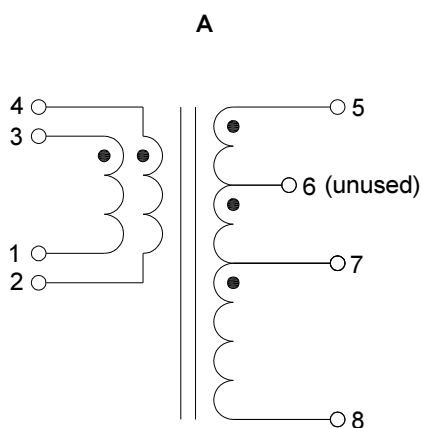

PIN1,2 and 3,4 must be connected on PCB

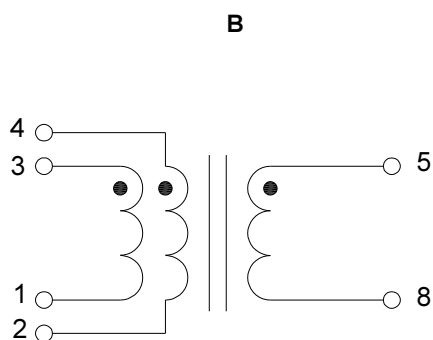

PIN1,2 and 3,4 must be connected on PCB

Dimension: (Units: $\frac{\text{Inches}}{\text{mm}}$)

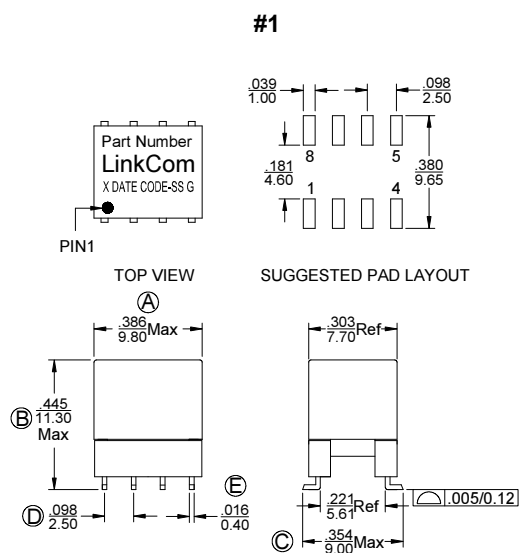

Voice band Applications - Silicon Labs

IC Number	LinkCom Part Number	Inductance (uH)	Schematic	Dimension
Si3217x, Si3226x	LDT0876-50	8.0	A	#1
Si3217x, Si3226x	LDT0887-50	8.0	B	#1
Si3217x, Si3226x (140V design)	LDT0905-50	2.0	C	#2

Schematics:

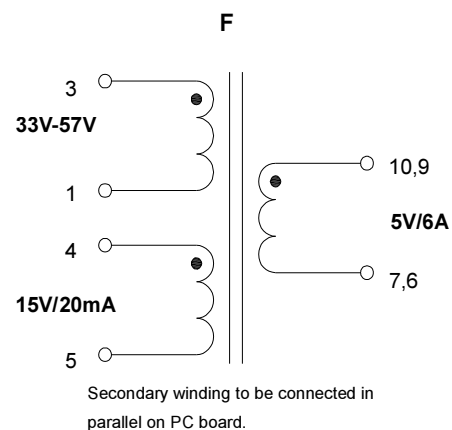
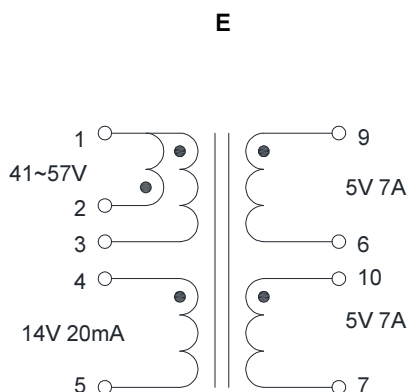
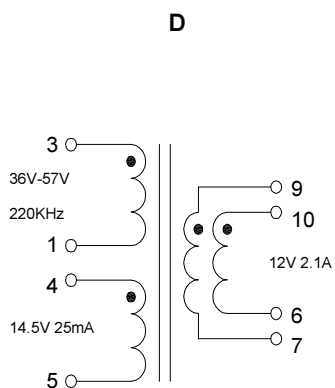
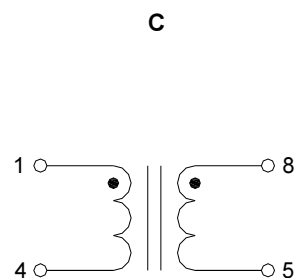
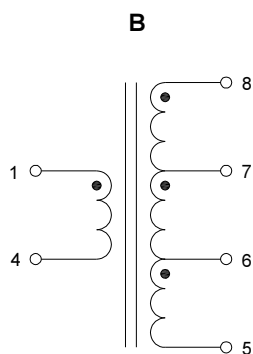
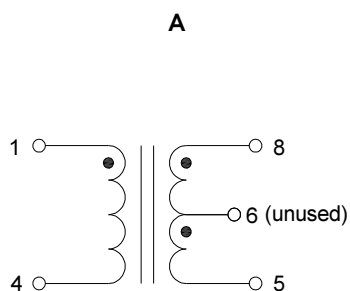

Voice band Applications - Silicon Labs

Dimension: (Units: $\frac{\text{Inches}}{\text{mm}}$)

#1 (EP-7)

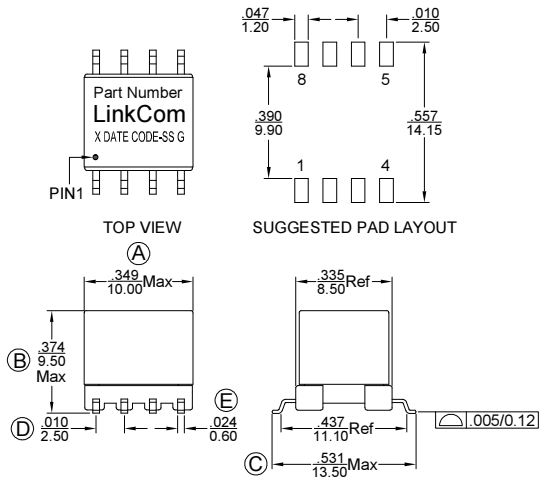

#2 (EP-7)

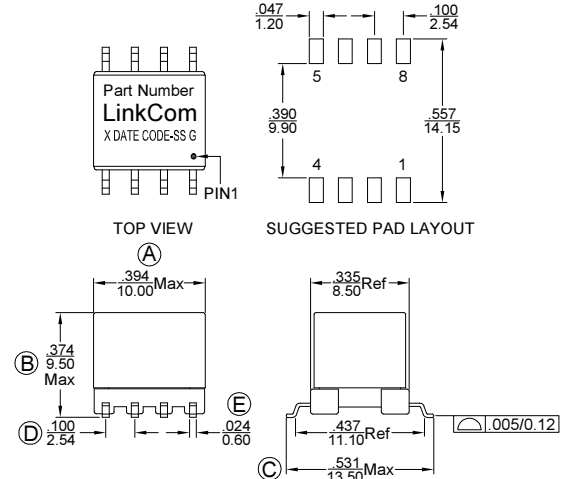

#3 (EP-13)

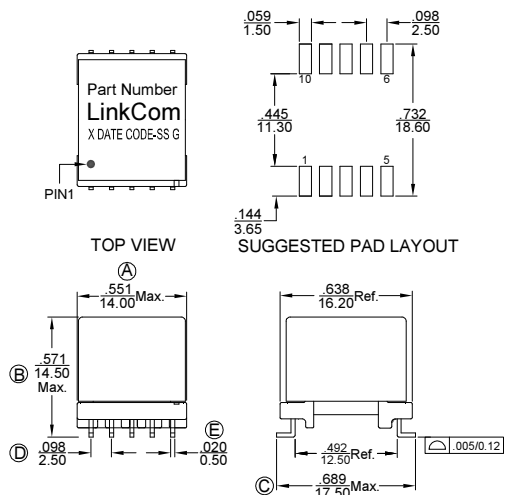

LAN Applications - 2.5/5G BASE-T Magnetic Module

- Meets IEEE 802.3bz standard for 2.5G BASE-T
- RoHS Compliant

LinkCom Part no.	Pin Style	Pin	Temperature	Application	Port	Schematic	Dimension
LAN7241-50	SMD	24	0°C ~70°C	2.5G Base-T	1	A	#1
LAN7241-53	SMD	24	0°C ~70°C	2.5G Base-T	1	B	#1
LAN7246-50	SMD	24	0°C ~70°C	5G Base-T	1	A	#1
LAN7246-53	SMD	24	0°C ~70°C	5G Base-T	1	B	#1

Schematics:



Dimension: (Units: mm)

#1

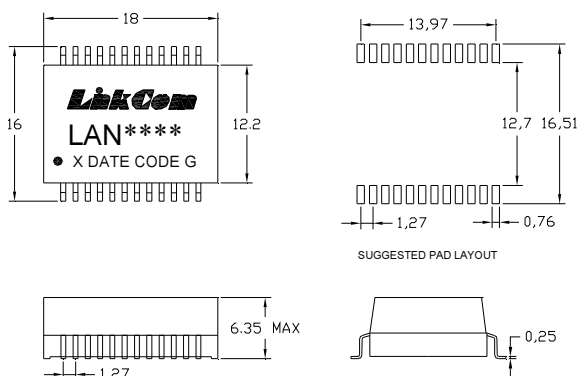

LAN Applications - 10/100/1000 BASE-T Magnetic Module

- Meets IEEE 802.3 standard for 10/100/1000 BASE-T
- RoHS Compliant

LinkCom Part no.	Pin Style	Pin	Temperature	Application	Port	Schematic	Dimension
LAN3003-80	SMD	24	0°C ~70°C	10/100/1000 Base-T	1	A	#1
LAN3004-83	SMD	24	0°C ~70°C	10/100/1000 Base-T	1	B	#1
LAN3007-80	SMD	48	0°C ~70°C	10/100/1000 Base-T	2	C	#2
LAN3241-52	DIP	24	0°C ~70°C	10/100/1000 Base-T	1	A	#3
LAN3482-50	DIP	48	0°C ~70°C	10/100/1000 Base-T	2	C	#4

Schematics:

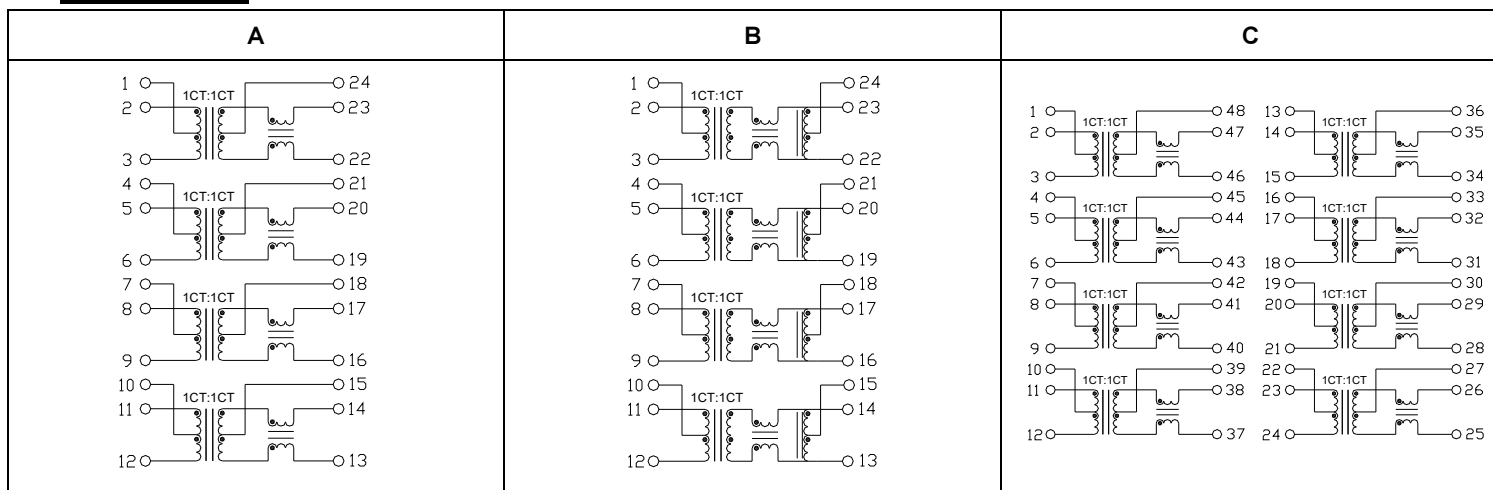

Dimension: (Units: mm)

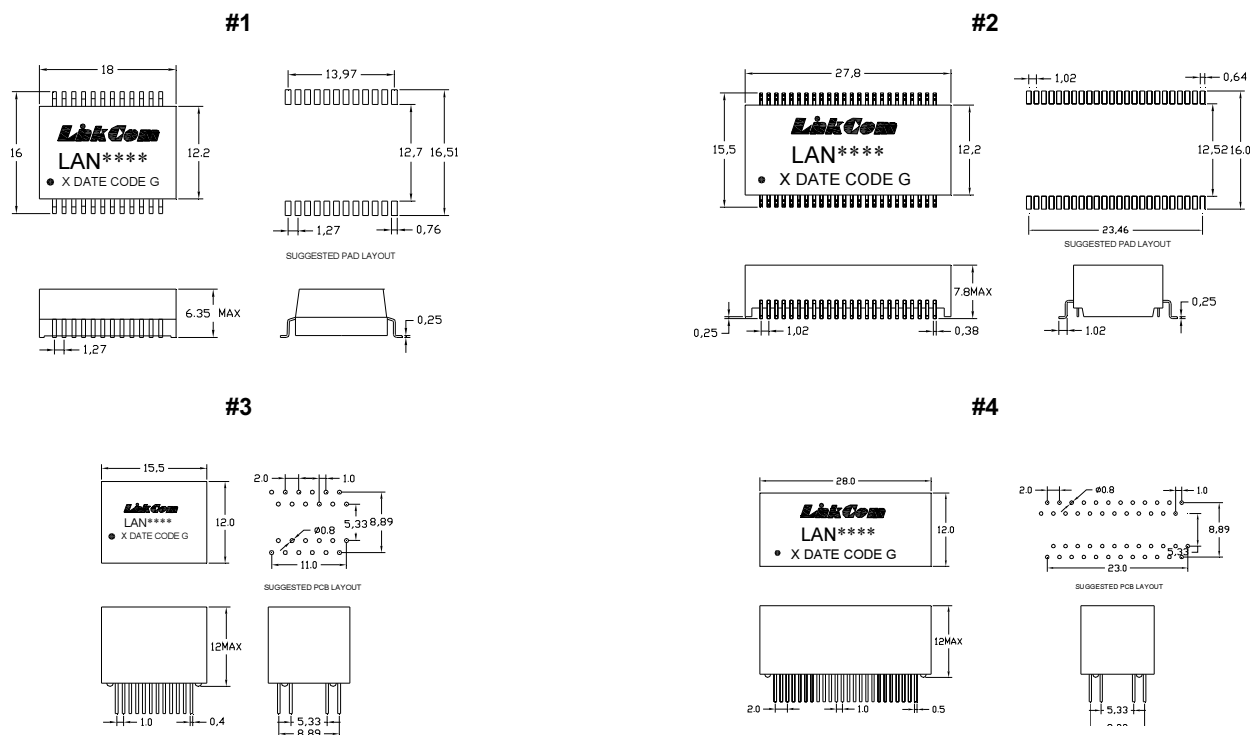

- Meets IEEE 802.3af standard for 10/100/1000 BASE-T

LAN Applications - 10/100/1000 BASE-T Magnetic Module

- RoHS Compliant

LinkCom Part no.	Pin Style	Pin	Temperature	Application	Port	Schematic	Dimension
LAN2019-51	SMD	16	0°C ~70°C	10/100 Base-T	1	A	#1
LAN2241-53	SMD	24	0°C ~70°C	10/100/1000 Base-T	1	B	#2
LAN2482-52	SMD	48	0°C ~70°C	10/100/1000 Base-T	2	C	#3

Schematics:

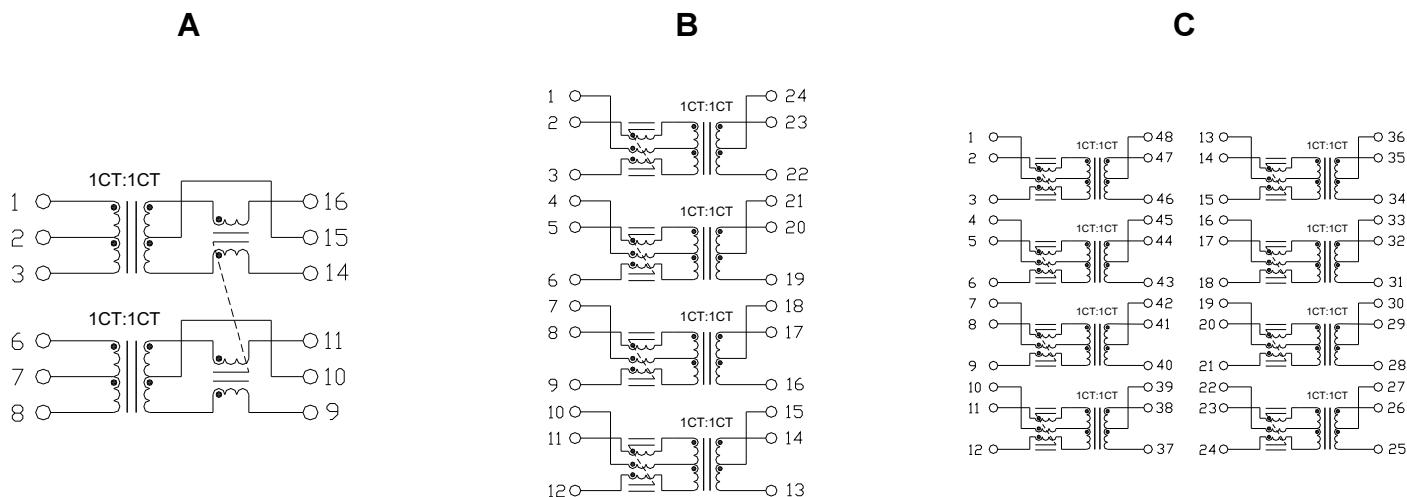

Dimension: (Units: mm)

#1

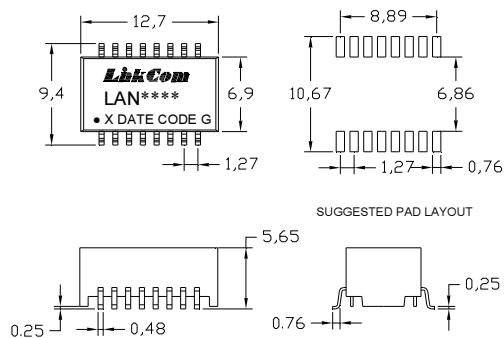

#2

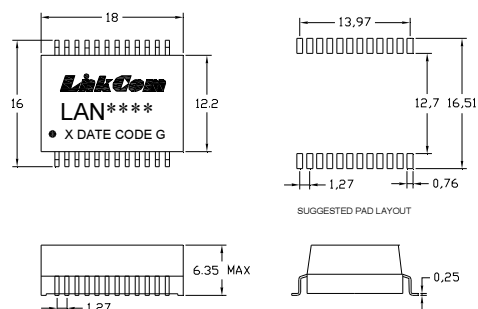

#3

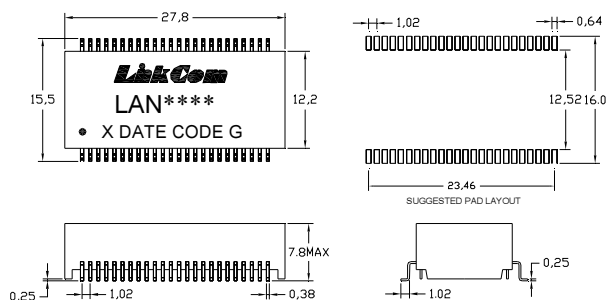

LAN Applications - 10/100 BASE-T Magnetic Module

- Meets IEEE 802.3 standard for 10/100 BASE-T
- RoHS Compliant

LinkCom Part no.	Pin Style	Pin	Temperature	Application	Port	Schematic	Dimension
LAN1102-80	SMD	16	0°C ~70°C	10/100 Base-T	1	A	#1
LAN1164-70	SMD	40	0°C ~70°C	10/100 Base-T	4	B	#3
LAN0068-50	DIP	20	0°C ~70°C	10/100 Base-T	2	C	#2

Schematics:

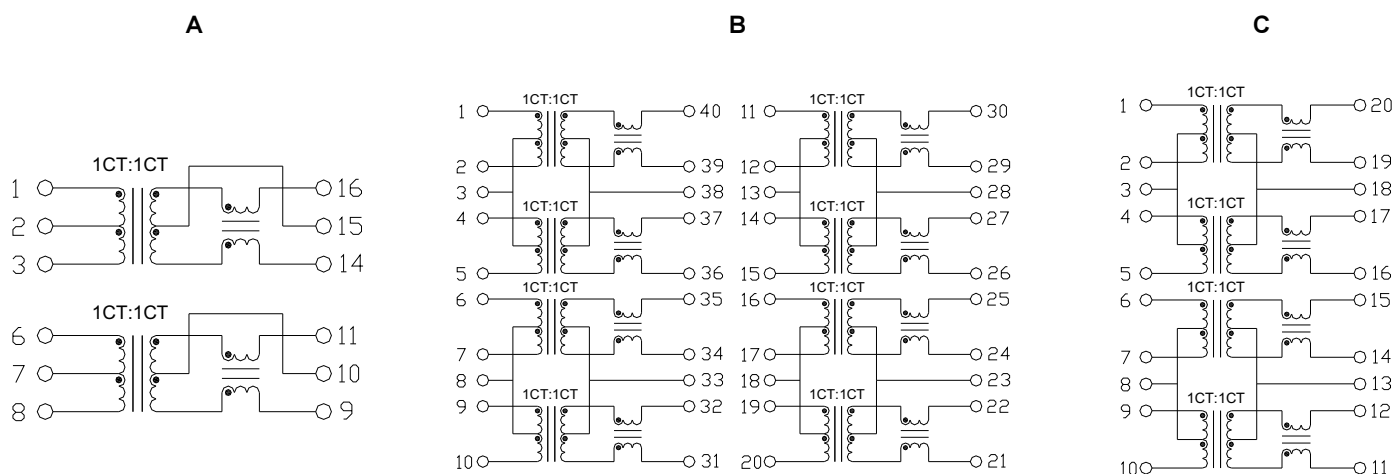

Dimension: (Units: mm)

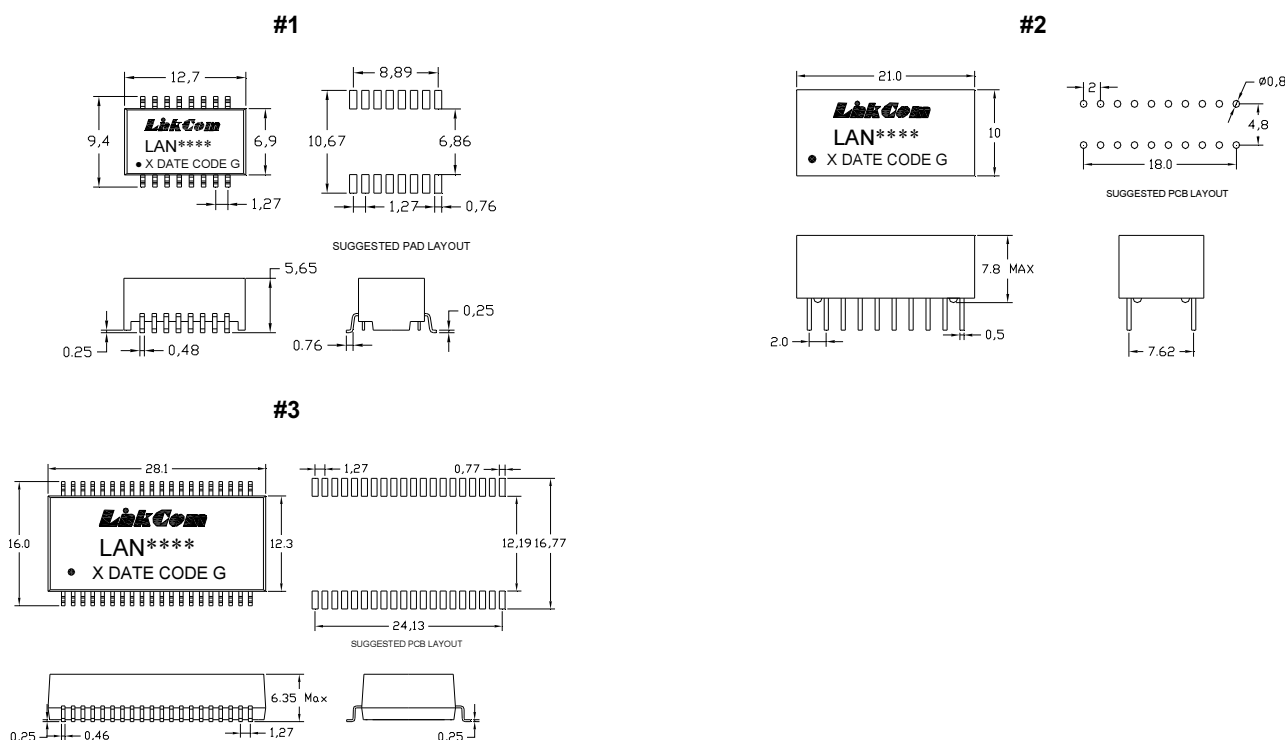

PoE Applications - Texas Instruments

IC Number	LinkCom Part Number	Watts	Input	Aux	Output	Inductance (uH)	Schematic	Package	Topology
TPS23785	LDT0567-50	13	36V-57V 250KHz	10.3V 20mA	O1: 3.3V/2A O2: 5V/1A O3: 10V/10mA	133±7%	A	#1(EP-13)	Flyback
TPS23785	LDT0568-50	13	36V-57V 250KHz	10.3V 20mA	O1: 3.3V/2A O2: 5V/1A O3: 10V/10mA	240±7%	A	#1(EP-13)	Flyback
TPS23785	LDT0571-50	13	36V-57V 250KHz	10.3V 20mA	O1: 3.3V/1.5A O2: 5V/1A O3: 10V/0.2A	220±7%	A	#1(EP-13)	Flyback
TPS23753	LDT0959-50	13	36V-57V 250KHz	10.3V 20mA	O1: 3.3V/3.3A O2: 10V/0.2A	133±7%	B	#2(EP-13)	Flyback
TPS23755	LDT0950-50	13	36V-57V 250KHz	13.5V 20mA	12V/1A	150±7%	C	#2(EP-13)	Flyback
TPS23755	LDT0939-50	13	36V-57V 250KHz	10.3V 20mA	O1: 3.3V/2A O2: 5V/1A O3: 10V/10mA	133±7%	A	#2(EP-13)	Flyback
TPS23758	LDT1018-50	13	36V-57V 250KHz	10.5V 20mA	5V/2.38A	150±7%	D	#3(EPD-13)	Flyback
TPS23758	LDT1023-50	13	36V-57V 250KHz	10V 20mA	3.3V/3.6A	140±7%	D	#3(EPD-13)	Flyback
TPS23758	LDT6003-50	36	36V-57V 250KHz	10.5V 20mA	5V/2.38A	150±7%	D	#2(EP-13)	Flyback
	LDT0687-50	25	37V-57V 250KHz	12V 20mA	5V/5A	50±10%	E	#5(EFD-17)	Flyback
TPS23751	LDT0666-50	25	37V-57V 250KHz	12V 20mA	5V/5A	70±10%	E	#6(EFD-20)	Flyback

PoE Applications - Texas Instruments

Schematics:

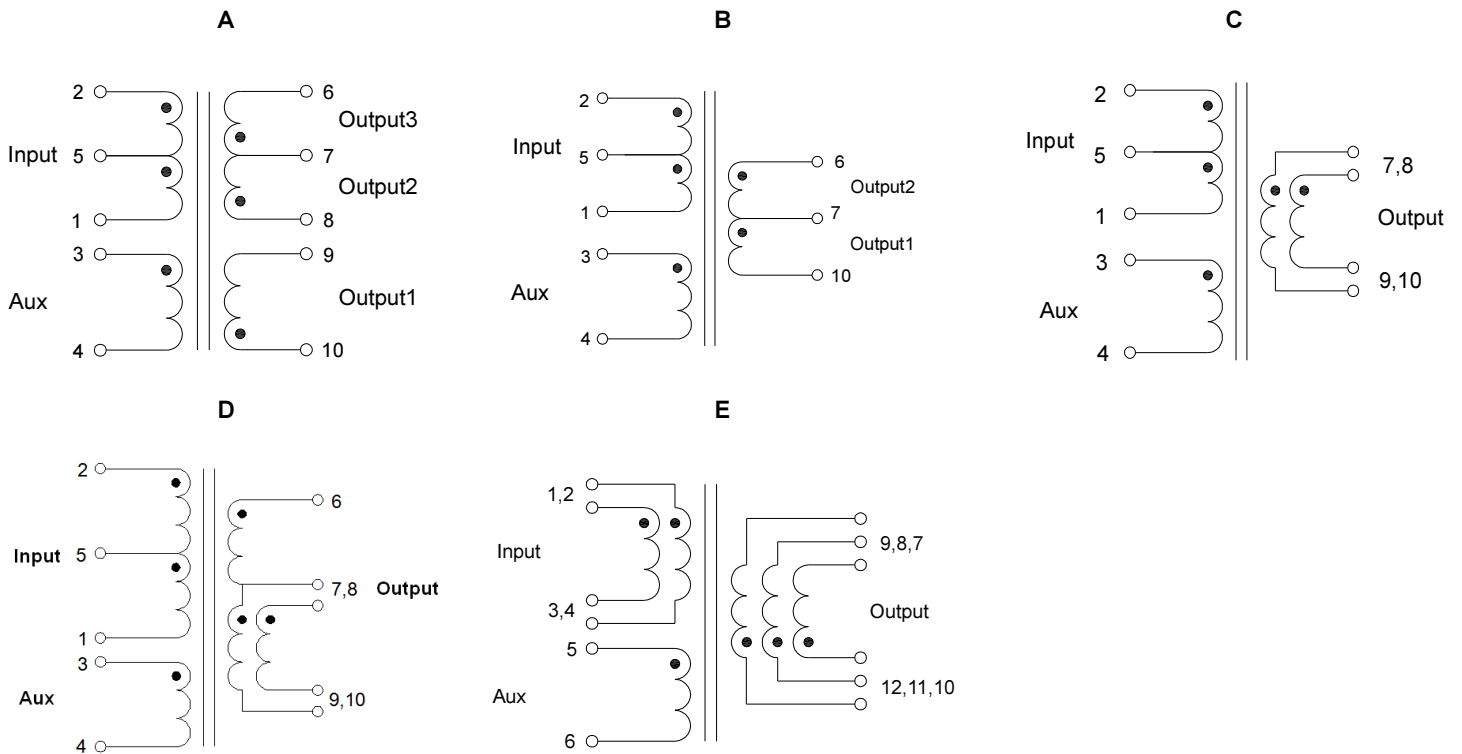

PoE Applications - Texas Instruments

Dimension: (Units: $\frac{\text{Inches}}{\text{mm}}$)

#1 (EP-13)

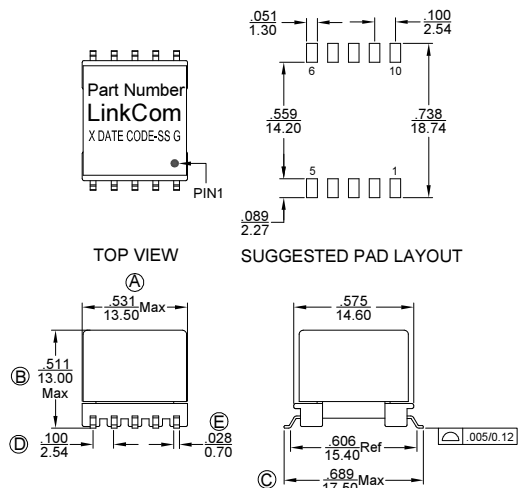

#2 (EP-13)

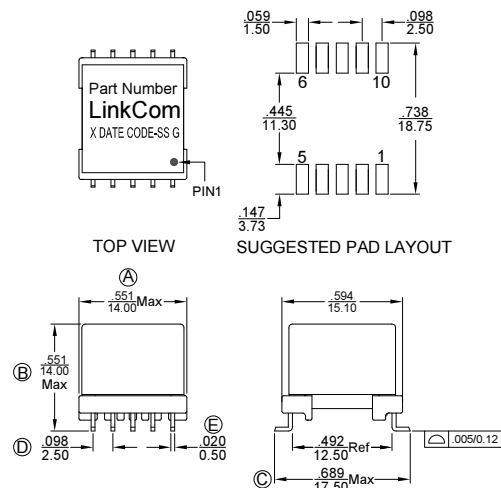

#3 (EPD-13)

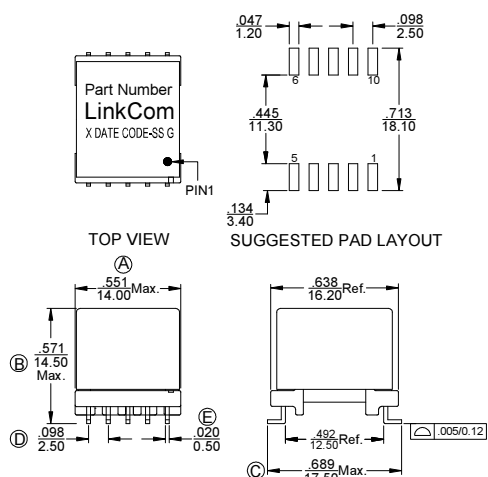

#4 (EFD-17)

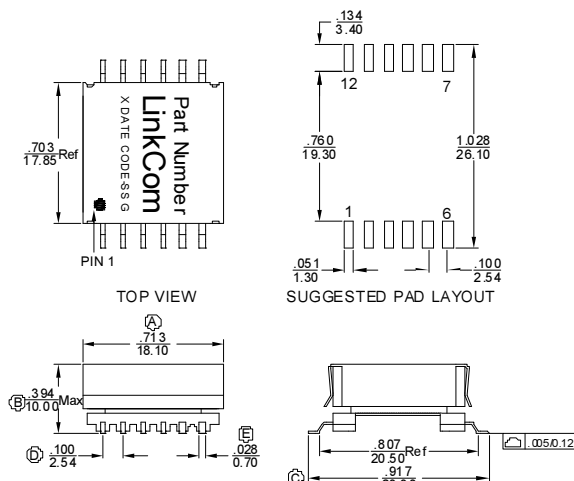

#5 (EFD-20)

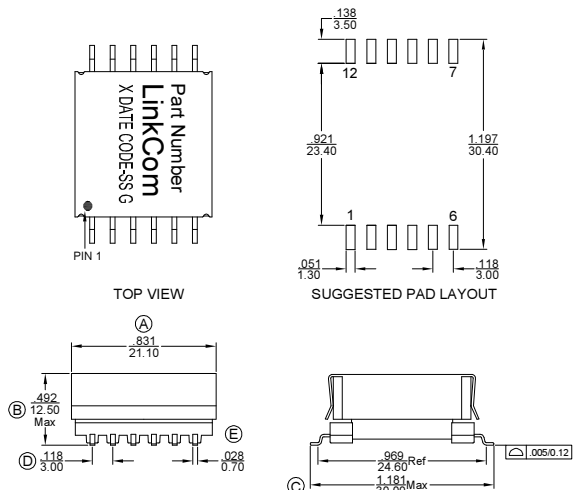

PoE Applications - Silicon Labs

Silicon Labs Part No.	LinkCom Part No.	WATTS	Input	Aux	Output	Inductance (uH)	Schematic	Package	Topology
	LDT0955-50	13	35V-57V 250KHz	15V 20mA	O: 12V/1.25A	70±7%	A	#1	Flyback
Si34061	LDT1020-50	30	35V-57V 250KHz	15V 20mA	O: 5V/6A	70±7%	A	#2	Flyback
Si34061	LDT1026-50	25	36V-57V 220KHz	14.5V 25mA	O: 12V/2.1A	80±7%	A	#2	Flyback
Si34071	LDT1056-50	35	41V~57V	14V 20mA	O: 5V/7A	100±15%	B	#2	Flyback

Schematics:

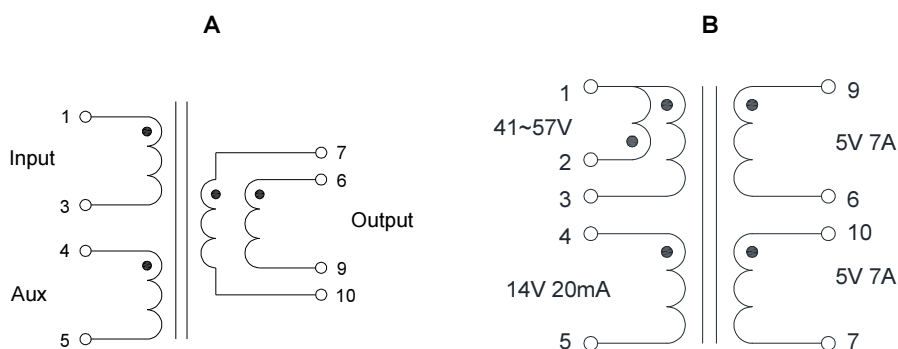

Dimension: (Units: $\frac{\text{Inches}}{\text{mm}}$)

#1 (EP-13)

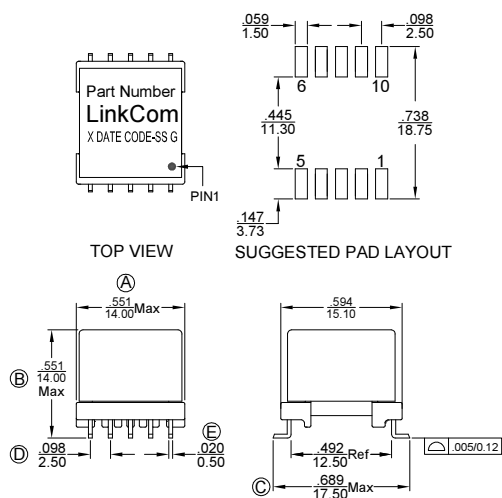

#2 (EPD-13)

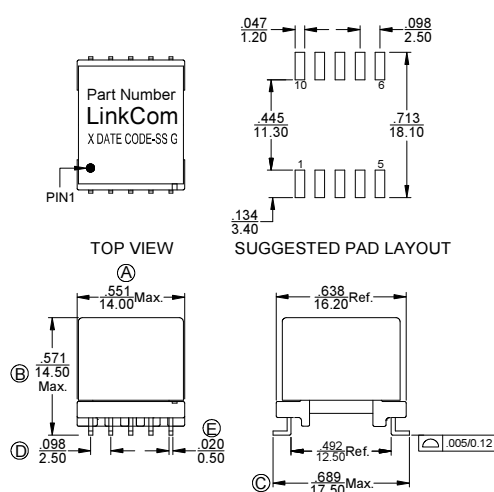

PoE Applications - Customized

LinkCom Part No.	Watts	Input	Aux	Output	Inductance (uH)	Schematic	Package	Topology
LDT0811-50	13	33V-57V/200KHz	12V/20mA	3.3V/4A	70±10%	A	#1	Flyback
LDT0812-50	13	33V-57V/200KHz	12V/20mA	5V/2.7A	70±10%	A	#1	Flyback
LDT0813-50	13	33V-57V/200KHz	12V/20mA	12V/1.125A	70±10%	A	#1	Flyback
LDT0821-50	25	37V-57V/250KHz	12V/20mA	3.3V/7.5A	37±10%	A	#1	Flyback
LDT0822-50	25	37V-57V/250KHz	12V/20mA	5V/5A	37±10%	A	#1	Flyback
LDT0823-50	25	37V-57V/250KHz	12V/20mA	12V/2.1A	37±10%	A	#1	Flyback
LDT0952-50	25	33V-57V/200KHz	12V/20mA	12V/1.8A	100±15%	A	#3	Forward
LDT1001-50	25	36V-57V/250KHz	10V/20mA	O1:3.3V/3.5A O2:3.3V/3.5A	62±10%	C	#2	Flyback
LDT1002-50	30	36V-57V/250KHz	10V/20mA	O1:5V/3A O2:5V/3A	55±10%	C	#2	Flyback
LDT0696-50	30	36V-72V/250KHz	12V/20mA	5V/6A	42±10%	B	#4	Flyback
LDT1003-50	36	36V-57V/250KHz	10V/20mA	O1:12V/1.5A O2:12V/1.5A	48±10%	C	#2	Flyback
LDT0817-50	50	36V-57V/250KHz	12V/30mA	12V/4.2A	65±10%	B	#6	Flyback

PoE Applications - Customized

Schematics:

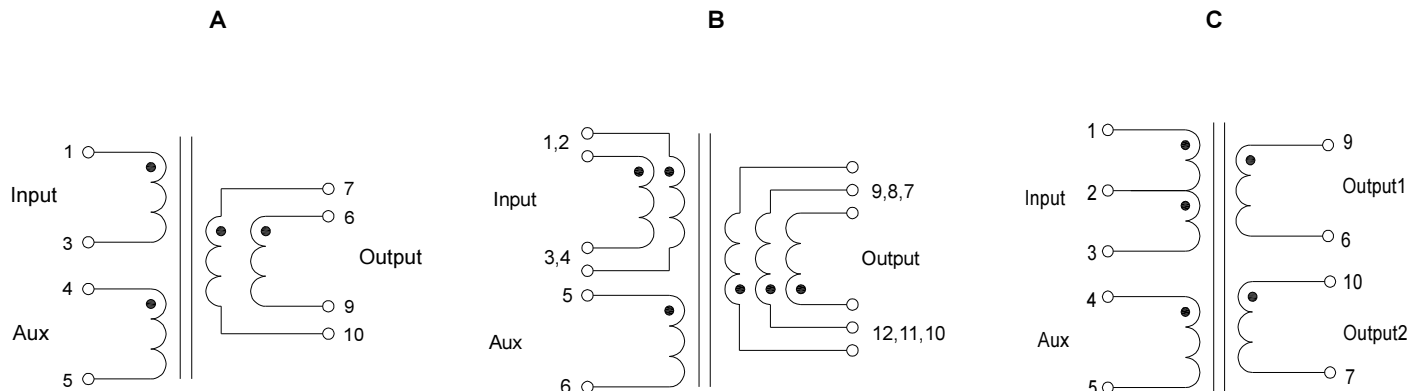

Dimension: (Units: $\frac{\text{Inches}}{\text{mm}}$)

#1 (EP-13)

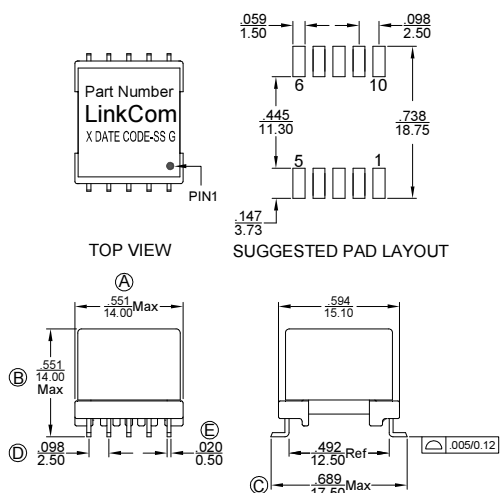

#2 (EPD-13)

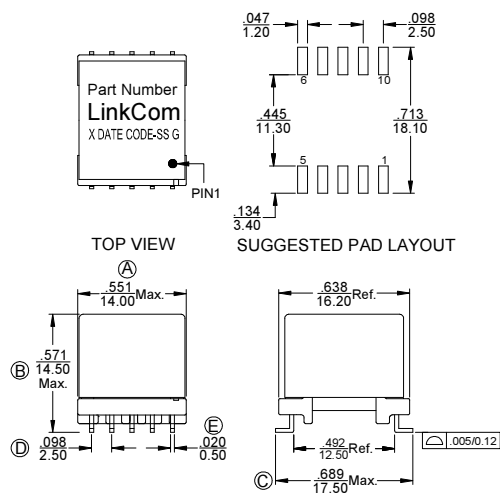

#3 (EFD-15)

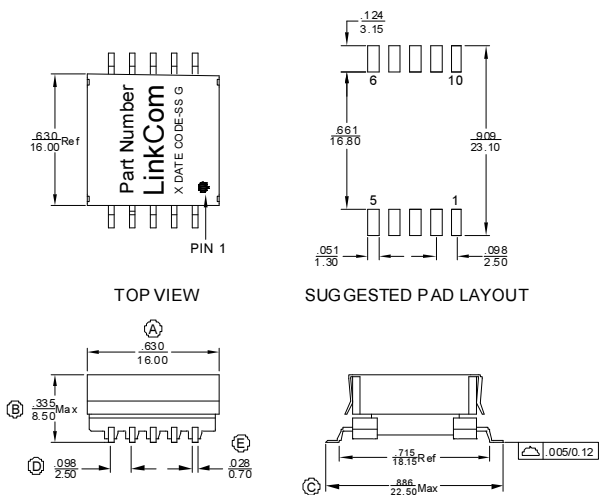

#4 (EFD-20)

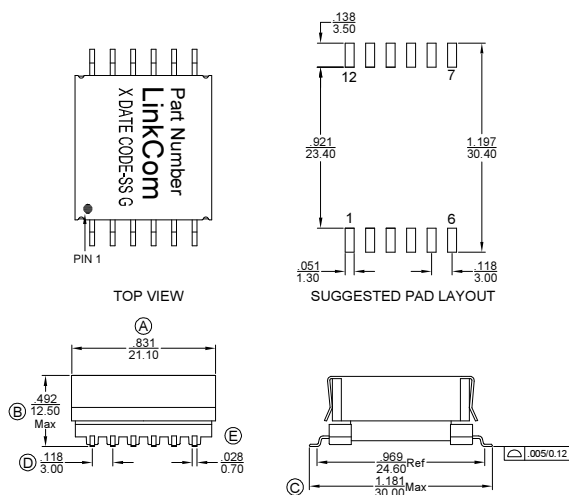

PoE Applications - Customized

#5 (EFD-17)

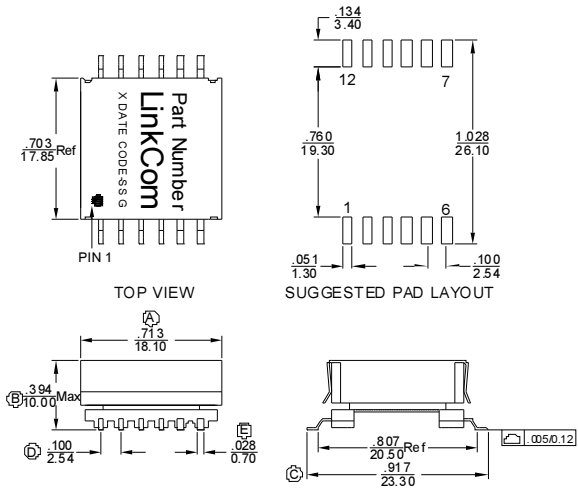

#6 (EFD-25)

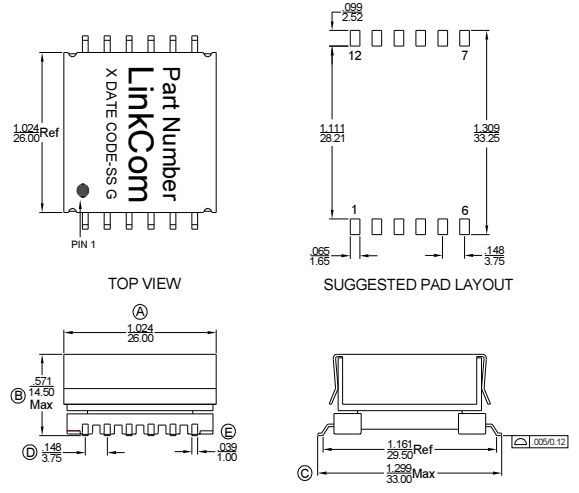

Gate-Drive Transformers

- 1500V_{DC} isolation between Gate and Drive
- Operating frequency: 50kHz and up

LinkCom Part No.	Turn Ratio	Primary inductance Min. (mH)	ET (V-usec)	Schematic	Package
LTC0266-50	1:1	1.000	27.2	A	#1
LTC0282-50	1:1	1.000	27.2	B	#2
LTC0557-50	1:1	0.785	9.7	C	#3
LTC0557-51	1:1	0.785	9.7	C	#4

Schematics:

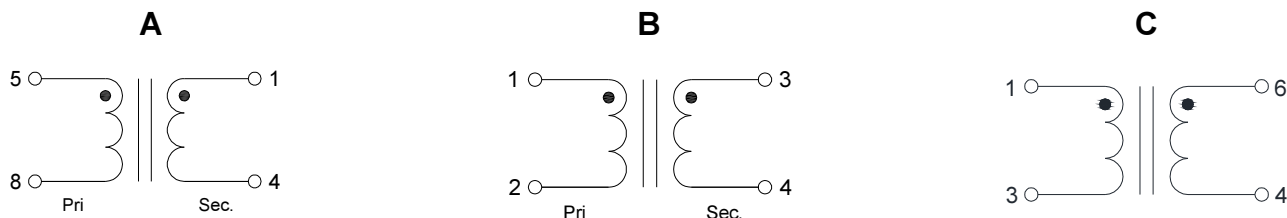

Dimension: (Units: $\frac{\text{Inches}}{\text{mm}}$)

#1

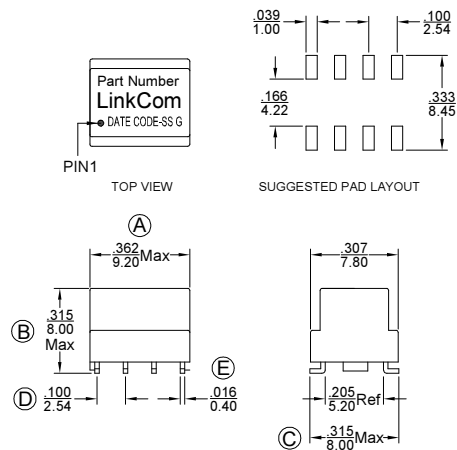

#2

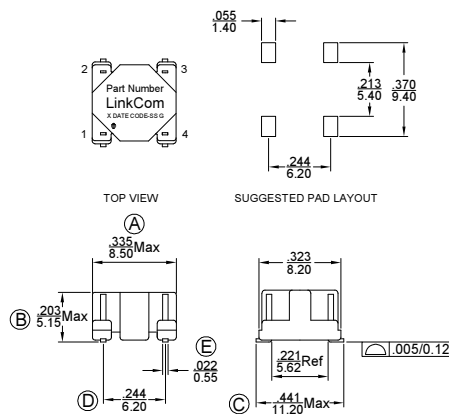

#3

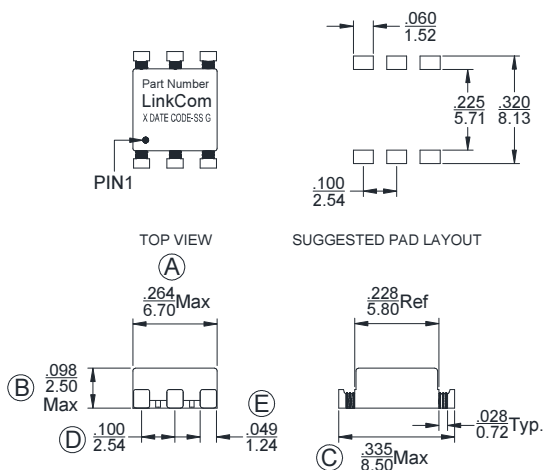

#4

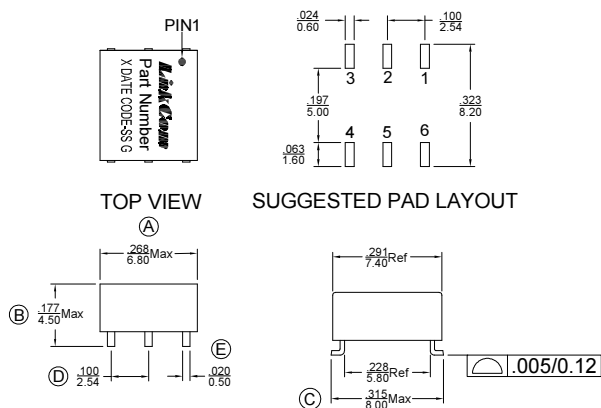

Current Sense Transformers – EE5 Series

- RoHS Compliant
- Operating Temperature -40°C to +125°C
- 500Vrms isolation between windings
- Frequency up to 1MHz
- 10A typical rated current on primary (up to 20A)

Electrical Specifications @25°C

Part Number	Code	Turns Ratio Pri. : Sec.	Secondary Inductance Min.(μH)	DCR		Volt-time product on Sec. Max.(V-μsec)	Terminating Resistance (1VSec./20APri.) (Ω)
				Pri. Ref.(mΩ).	Sec. Max.(Ω)		
LCS0007-50	020	1:20	81	7	0.40	10.8	1.00
LCS0008-50	030	1:30	180	7	0.87	16.2	1.50
LCS0009-50	040	1:40	320	7	1.14	21.6	2.00
LCS0010-50	050	1:50	500	7	1.50	27.0	2.50
LCS0011-50	060	1:60	730	7	1.98	32.4	3.00
LCS0012-50	070	1:70	980	7	4.75	37.8	3.50
LCS0013-50	100	1:100	2000	7	5.50	54.0	5.00
LCS0015-50	125	1:125	3000	7	7.00	67.5	6.25

Dimensions

(Units: $\frac{\text{Inches}}{\text{mm}}$, Unless otherwise specified, all tolerances are ± 0.25)

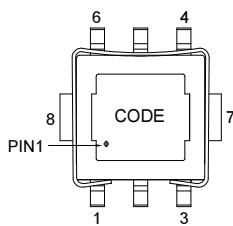

TOP VIEW

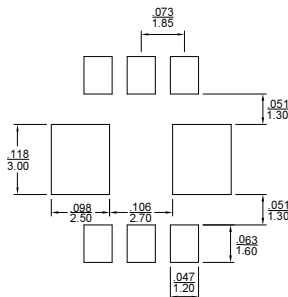

SUGGESTED PAD LAYOUT

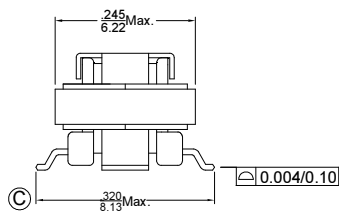
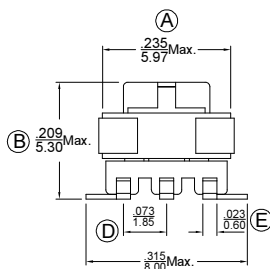

Schematic

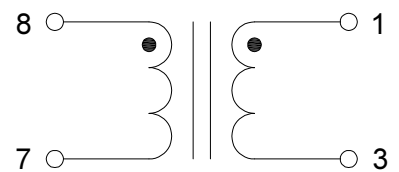

Mark

Code----Number of turns on secondary

Current Sense Transformers – EF12 Series

- RoHS Compliant
- Operating Temperature -40°C to +125°C
- 500Vrms isolation between windings
- Frequency up to 1MHz
- Up to 40A of rated current on primary

Electrical Specifications @25°C

Part Number	Turns Ratio Pri. : Sec.	Secondary Inductance Min.(mH)	D.C.R.		Volt-time product on Sec. Max.(V-μsec)	Terminating Resistance (1VSec./40APri.) (Ω)
			Pri. Ref.(mΩ)	Sec. Max.(Ω)		
LCS0027-50	1:20	0.34	1	0.180	50.8	0.5
LCS0028-50	1:30	0.76	1	0.265	76.2	0.8
LCS0029-50	1:40	1.36	1	0.560	101.6	1.0
LCS0030-50	1:50	2.12	1	0.705	127.0	1.3
LCS0031-50	1:60	3.06	1	0.850	152.4	1.5
LCS0032-50	1:70	4.16	1	1.00	177.8	1.8
LCS0033-50	1:80	5.44	1	1.15	203.2	2.0
LCS0035-50	1:100	8.50	1	1.45	254.0	2.5
LCS0036-50	1:125	13.3	1	1.85	317.5	3.1
LCS0037-50	1:150	19.2	1	2.25	381.0	3.8
LCS0038-50	1:200	34.0	1	4.06	508.0	5.0

Dimensions

(Units: $\frac{\text{Inches}}{\text{mm}}$, Unless otherwise specified, all tolerances are $\pm\frac{.010}{0.25}$)

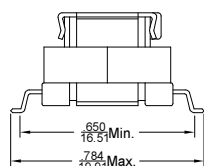
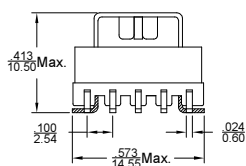
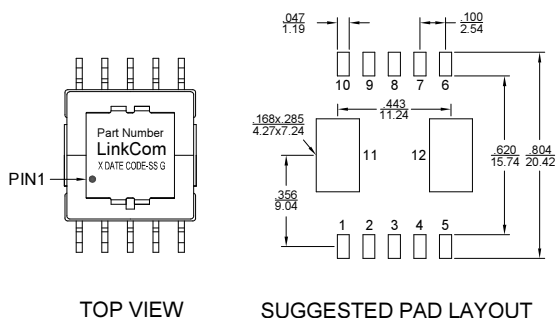

Schematic

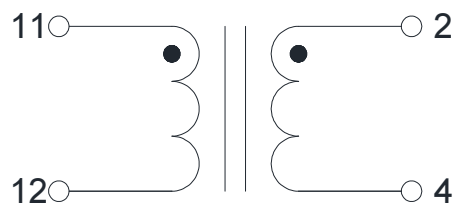

Mark

1. Part Number----LCSxxxx
2. X----PRODUCT LINE OR BLANK
3. DATE CODE----YYWW
4. SS----50 OR BLANK
5. G----RoHS



SMD Power Inductors

Features:

- Applicable at high frequency up to 1MHz
- Magnetic-resin shielded construction reduces buzz noise to ultra-low levels.
- Metallization on ferrite core results in excellent shock resistance and damage-free durability.
- Closed magnetic circuit design reduces leakage flux and Electro Magnetic Interference (EMI).
- 30% higher Current rating than conventional inductors of equal size.
- RoHS compliant.
- Operating Temperature Range -40°C ~ +125°C (Including self-heating)

Applications:

- LED Lighting
- Flat-screen TVs, blue-ray disc recorders, set top box, movie cameras, smart phone
- Notebooks, desktop computers, servers, graphic cards
- Portable gaming devices, personal navigation systems, personal multimedia devices
- Telecomm base stations
- DC/DC converters

Product Identification:

①	②	③		④	⑤	⑥		⑦
LNR	2510A	A	-	1R0	M	R	-	02

①	Type
LNR	Power inductors

③	Electrical specification Code
A	A Type
B	B Type

②	(L×W×H) [mm] External Dimensions
2510A	2.5x2.1x1.0
2512A	2.5x2.1x1.2
3010A	3.0x3.0x1.05
3015A	3.0x3.0x1.5
4012A	4.0x4.0x1.2
4018A	4.0x4.0x1.8
5020A	5.0x5.0x2.0
5040A	5.0x5.0x4.0
6020A	6.0x6.0x2.0
6028A	6.0x6.0x2.8
6045A	6.0x6.0x4.5
8040A	8.0x8.0x4.0

④	Nominal Inductance
1R0	1.0μH
100	10.0μH

⑤	Inductance Tolerance
K	±10%
M	±20%
N	±30%

⑥	Packing
Standard	Tape Reel Package

⑦	Internal code
01	
02	



SMD Power Inductors

Shape And Dimensions [Unit: mm]

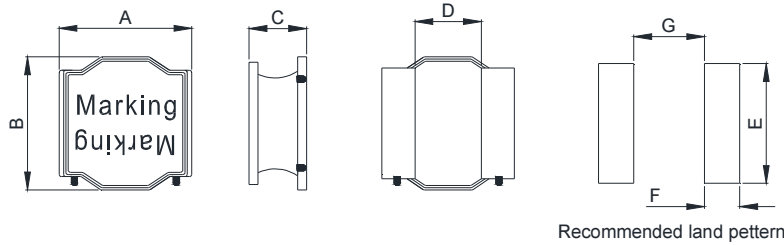

Series	A	B	C	D	E (Ref.)	F (Ref.)	G (Ref.)
LNR2510AA	2.5±0.25	2.1±0.25	1.0 Max.	0.9	2.2	0.95	0.8
LNR2512AA	2.5±0.25	2.1±0.25	1.2 Max.	0.9	2.2	0.95	0.8
LNR3010AA	3.0±0.2	3.0±0.2	1.05 Max.	1.0	2.7	0.8	1.4
LNR3015AA	3.0±0.2	3.0±0.2	1.5 Max.	1.0	2.7	0.8	1.4
LNR4012AA	4.0±0.2	4.0±0.2	1.2+0.1/-0.15	1.4	3.7	1.2	1.6
LNR4018AA	4.0±0.2	4.0±0.2	1.8±0.2	1.4	3.7	1.2	1.6
LNR5020AA	5.0±0.2	5.0±0.2	2.0±0.2	2.0	4.7	1.4	2.4
LNR5040AA	5.0±0.2	5.0±0.2	4.0±0.2	2.0	4.7	1.4	2.4
LNR6020AA	6.0±0.2	6.0±0.2	2.0±0.2	2.7	5.7	1.6	3.1
LNR6028AA	6.0±0.2	6.0±0.2	2.8±0.2	2.7	5.7	1.6	3.1
LNR6045AA	6.0±0.2	6.0±0.2	4.5+0.2/-0.3	2.7	5.7	1.6	3.1
LNR8040AA	8.0±0.2	8.0±0.2	4.0+0.2/-0.3	3.9±0.2	7.7	2.3	3.8

Electrical Characteristics

LNR2510AA Series						
P/N	Inductance (μH)	Test Freq. (MHz)	Tolerance (±%)	DCR (mΩ) (Max)	Isat (Max)	Idc (Max)
LNR2510A A-R33MR-02	0.33	1.0	20	39	5.50	4.00
LNR2510A A-R47MR-02	0.47	1.0	20	45	5.20	3.60
LNR2510A A-R68MR-02	0.68	1.0	20	59	3.60	3.00
LNR2510A A-1R0MR-02	1.0	1.0	20	76	3.50	2.70
LNR2510A A-1R5MR-02	1.5	1.0	20	100	3.00	2.05
LNR2510A A-2R2MR-02	2.2	1.0	20	135	2.40	1.90
LNR2510A A-3R3MR-02	3.3	1.0	20	235	1.80	1.50
LNR2510A A-4R7MR-02	4.7	1.0	20	276	1.50	1.30
LNR2510A A-6R8MR-02	6.8	1.0	20	416	1.30	1.12
LNR2510A A-100MR-02	10	1.0	20	500	1.20	0.95
LNR2510A A-220MR-02	22	1.0	20	1300	0.80	0.65



SMD Power Inductors

LNR2512AA Series						
P/N	Inductance (μ H)	Test Freq. (MHz)	Tolerance (\pm %)	DCR (m Ω) (Max)	Isat (Max)	Idc (Max)
LNR2512AA-R33MR-02	0.33	1.0	20	30	6.20	4.00
LNR2512AA-R47MR-02	0.47	1.0	20	35	5.60	4.00
LNR2512AA-R68MR-02	0.68	1.0	20	43	5.50	3.40
LNR2512AA-1R0MR-02	1.0	1.0	20	64	4.40	3.00
LNR2512AA-1R5MR-02	1.5	1.0	20	85	3.60	2.53
LNR2512AA-2R2MR-02	2.2	1.0	20	120	3.00	2.18
LNR2512AA-3R3MR-02	3.3	1.0	20	163	2.10	1.75
LNR2512AA-4R7MR-02	4.7	1.0	20	260	1.90	1.31
LNR2512AA-6R8MR-02	6.8	1.0	20	366	1.50	1.15
LNR2512AA-100MR-02	10	1.0	20	480	1.25	0.99
LNR2512AA-150MR-02	15	1.0	20	774	1.05	0.77
LNR2512AA-220MR-02	22	1.0	20	1210	0.80	0.65

LNR3010AA Series						
P/N	Inductance (μ H)	Test Freq. (MHz)	Tolerance (\pm %)	DCR (m Ω) \pm 30%	Isat (Max)	Idc (Max)
LNR3010AA-1R5NR-02	1.5	1.0	30	85	1.62	1.53
LNR3010AA-2R2NR-02	2.2	1.0	30	100	1.35	1.26
LNR3010AA-3R3NR-02	3.3	1.0	30	165	1.08	0.99
LNR3010AA-4R7NR-02	4.7	1.0	30	205	0.90	0.85
LNR3010AA-6R8MR-02	6.8	1.0	20	310	0.78	0.76
LNR3010AA-100MR-02	10	1.0	20	430	0.57	0.56
LNR3010AA-150MR-02	15	1.0	20	625	0.50	0.49
LNR3010AA-220MR-02	22	1.0	20	1095	0.42	0.41



SMD Power Inductors

LNR3015AA Series						
P/N	Inductance (μ H)	Test Freq. (MHz)	Tolerance (\pm %)	DCR (m Ω) \pm 30%	Isat (Max)	Idc (Max)
LNR3015AA-R47NR-02	0.47	1.0	30	36	4.23	3.60
LNR3015AA-1R0NR-02	1.0	1.0	30	54	3.06	2.70
LNR3015AA-1R5NR-02	1.5	1.0	30	63	2.70	2.34
LNR3015AA-2R2NR-02	2.2	1.0	30	90	2.07	1.80
LNR3015AA-3R3NR-02	3.3	1.0	30	125	1.71	1.62
LNR3015AA-4R7NR-02	4.7	1.0	30	170	1.42	1.36
LNR3015AA-6R8MR-02	6.8	1.0	20	235	1.20	1.17
LNR3015AA-100MR-02	10	1.0	20	360	0.95	0.90
LNR3015AA-150MR-02	15	1.0	20	550	0.81	0.72
LNR3015AA-220MR-02	22	1.0	20	770	0.68	0.58

LNR4012AA Series						
P/N	Inductance (μ H)	Test Freq. (MHz)	Tolerance (\pm %)	DCR (m Ω) \pm 30%	Isat (Max)	Idc (Max)
LNR4012AA-1R0NR-02	1.0	1.0	30	40	2.61	2.7
LNR4012AA-1R5NR-02	1.5	1.0	30	51	2.07	2.25
LNR4012AA-2R2NR-02	2.2	1.0	30	68	1.71	2.07
LNR4012AA-3R3NR-02	3.3	1.0	30	75	1.36	1.89
LNR4012AA-4R7NR-02	4.7	1.0	30	110	1.18	1.62
LNR4012AA-6R8MR-02	6.8	1.0	20	165	0.97	1.35
LNR4012AA-100MR-02	10	1.0	20	225	0.81	1.08

LNR4018AA Series						
P/N	Inductance (μ H)	Test Freq. (MHz)	Tolerance (\pm %)	DCR (m Ω) \pm 30%	Isat (Max)	Idc (Max)
LNR4018AA-1R0NR-02	1.0	1.0	30	26.5	3.78	3.42
LNR4018AA-1R5NR-02	1.5	1.0	30	37	3.15	2.88
LNR4018AA-2R2NR-02	2.2	1.0	30	47	2.70	2.43
LNR4018AA-3R3NR-02	3.3	1.0	30	62.5	2.07	1.89
LNR4018AA-4R7NR-02	4.7	1.0	30	80	1.80	1.62
LNR4018AA-6R8MR-02	6.8	1.0	20	115	1.35	1.21
LNR4018AA-100MR-02	10	1.0	20	185	1.26	1.08



SMD Power Inductors

LNR5020AA Series						
P/N	Inductance (μ H)	Test Freq. (MHz)	Tolerance (\pm %)	DCR (m Ω) \pm 30%	Isat (Max)	Idc (Max)
LNR5020AA-1R0NR-02	1.0	1.0	30	18	5.40	3.69
LNR5020AA-1R5NR-02	1.5	1.0	30	23	4.41	3.15
LNR5020AA-2R2NR-02	2.2	1.0	30	30	3.60	2.97
LNR5020AA-3R3NR-02	3.3	1.0	30	50	2.70	2.50
LNR5020AA-4R7NR-02	4.7	1.0	30	60	2.43	1.98
LNR5020AA-6R8MR-02	6.8	1.0	20	93	1.98	1.62
LNR5020AA-100MR-02	10	1.0	20	125	1.62	1.44
LNR5020AA-150MR-02	15	1.0	20	195	1.26	1.08
LNR5020AA-220MR-02	22	1.0	20	265	1.08	0.90

LNR5040AA Series						
P/N	Inductance (μ H)	Test Freq. (MHz)	Tolerance (\pm %)	DCR (m Ω) \pm 30%	Isat (Max)	Idc (Max)
LNR5040AA-1R0NR-02	1.0	1.0	30	12	7.92	5.31
LNR5040AA-1R5NR-02	1.5	1.0	30	14	7.11	4.86
LNR5040AA-2R2NR-02	2.2	1.0	30	20	6.12	4.05
LNR5040AA-3R3NR-02	3.3	1.0	30	26	4.77	3.78
LNR5040AA-4R7NR-02	4.7	1.0	30	32	3.96	2.88
LNR5040AA-6R8MR-02	6.8	1.0	20	50	3.42	2.7
LNR5040AA-100MR-02	10	1.0	20	70	2.70	2.07
LNR5040AA-150MR-02	15	1.0	20	115	2.16	1.62
LNR5040AA-220MR-02	22	1.0	20	160	1.80	1.44



SMD Power Inductors

LNR6020AA Series						
P/N	Inductance (μ H)	Test Freq. (MHz)	Tolerance (\pm %)	DCR (m Ω) \pm 30%	Isat (Max)	Idc (Max)
LNR6020AA-1R0NR-02	1.0	1.0	30	19	5.76	3.78
LNR6020AA-1R5NR-02	1.5	1.0	30	26	4.86	3.33
LNR6020AA-2R2NR-02	2.2	1.0	30	34	4.05	2.97
LNR6020AA-3R3NR-02	3.3	1.0	30	45	3.24	2.52
LNR6020AA-4R7NR-02	4.7	1.0	30	58	2.70	2.07
LNR6020AA-6R8MR-02	6.8	1.0	20	85	2.34	1.71
LNR6020AA-100MR-02	10	1.0	20	130	1.89	1.44
LNR6020AA-150MR-02	15	1.0	20	195	1.44	1.17
LNR6020AA-220MR-02	22	1.0	20	260	1.17	0.99

LNR6028AA Series						
P/N	Inductance (μ H)	Test Freq. (MHz)	Tolerance (\pm %)	DCR (m Ω) \pm 30%	Isat (Max)	Idc (Max)
LNR6028AA-1R0NR-02	1.0	1.0	30	12	7.11	5.67
LNR6028AA-1R5NR-02	1.5	1.0	30	15	6.30	4.95
LNR6028AA-2R2NR-02	2.2	1.0	30	20	5.40	4.50
LNR6028AA-3R3NR-02	3.3	1.0	30	27	4.05	3.60
LNR6028AA-4R7NR-02	4.7	1.0	30	36	3.60	3.06
LNR6028AA-6R8MR-02	6.8	1.0	20	48	2.88	2.70
LNR6028AA-100MR-02	10	1.0	20	65	2.34	2.25
LNR6028AA-150MR-02	15	1.0	20	93	1.89	1.80
LNR6028AA-220MR-02	22	1.0	20	135	1.53	1.48

LNR6045AA Series						
P/N	Inductance (μ H)	Test Freq. (MHz)	Tolerance (\pm %)	DCR (m Ω) \pm 30%	Isat (Max)	Idc (Max)
LNR6045AA-1R5NR-02	1.5	1.0	30	12	10.80	5.94
LNR6045AA-2R2NR-02	2.2	1.0	30	18	8.55	4.68
LNR6045AA-3R3NR-02	3.3	1.0	30	22	7.02	3.96
LNR6045AA-4R7NR-02	4.7	1.0	30	30	6.12	3.6
LNR6045AA-6R8MR-02	6.8	1.0	20	42	5.13	2.97
LNR6045AA-100MR-02	10	1.0	20	60	4.14	2.34
LNR6045AA-150MR-02	15	1.0	20	90	3.42	1.98
LNR6045AA-220MR-02	22	1.0	20	130	2.97	1.71



SMD Power Inductors

LNR8040AA Series						
P/N	Inductance (μ H)	Test Freq. (MHz)	Tolerance (\pm %)	DCR (m Ω) \pm 30%	Isat (Max)	Idc (Max)
LNR8040AA-1R0NR-02	1.0	1.0	30	7.5	12.15	7.29
LNR8040AA-1R5NR-02	1.5	1.0	30	9.7	9.45	6.93
LNR8040AA-2R2NR-02	2.2	1.0	30	12	8.73	6.48
LNR8040AA-3R3NR-02	3.3	1.0	30	17	7.20	5.31
LNR8040AA-4R7NR-02	4.7	1.0	30	20	6.12	4.95
LNR8040AA-6R8MR-02	6.8	1.0	20	29	5.22	4.41
LNR8040AA-100MR-02	10	1.0	20	38	4.50	3.42
LNR8040AA-150MR-02	15	1.0	20	57	3.60	2.88
LNR8040AA-220MR-02	22	1.0	20	82	3.06	2.43

NOTE :

- ⊙ Testing frequency: 1MHz/1V
- ⊙ All test Data is referenced to 20°C ambient
- ⊙ Typical Heat Rating DC Current (Idc) would cause NR approximately Δ T of 40°C
- ⊙ Typical Saturation DC Current (Isat) would cause open load inductance to drop approximately 30%

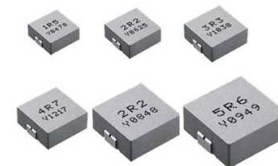

Molding Power Inductors

Features:

- Magnetic-resin shielded construction reduces buzz noise to ultra-low levels.
- Metallization on ferrite core results in excellent shock resistance and damage-free durability.
- Closed magnetic circuit design reduces leakage flux and Electro Magnetic Interference (EMI).
- Applicable at high frequency up to 750kHz.
- RoHS compliant.
- Operating Temperature Range -40°C ~ +125°C (Including self-heating)

Applications:

- LED Lighting
- Flat-screen TVs, blue-ray disc recorders, set top box, movie cameras, smart phone
- Notebooks, desktop computers, servers, graphic cards
- Portable gaming devices, personal navigation systems, personal multimedia devices
- Telecomm base stations
- VRM for server

Product Identification:

①	②	③		④	⑤	⑥		⑦
LML	0412A	A	-	1R0	M	R	-	02

①	Type
LML	Molding Power inductors

②	(L×W×H) [mm] External Dimensions
0420A	4.1x4.6x2.0
0530A	5.2x5.4x2.8
0612A	6.6x7.1x1.0
0618A	6.6x7.1x1.6
0624A	6.6x7.1x2.4
0630A	6.6x7.1x3.0

③	Electrical specification Code
A	A Type
B	B Type

④	Nominal Inductance
1R0	1.0μH
100	10.0μH

⑤	Inductance Tolerance
K	±10%
M	±20%
N	±30%

⑥	Packing
Standard	Tape Reel Package

⑦	Internal code
01	
02	

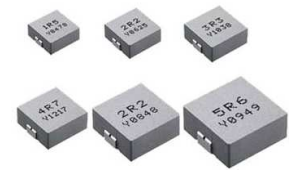

Molding Power Inductors

Shape And Dimensions [Unit: mm]

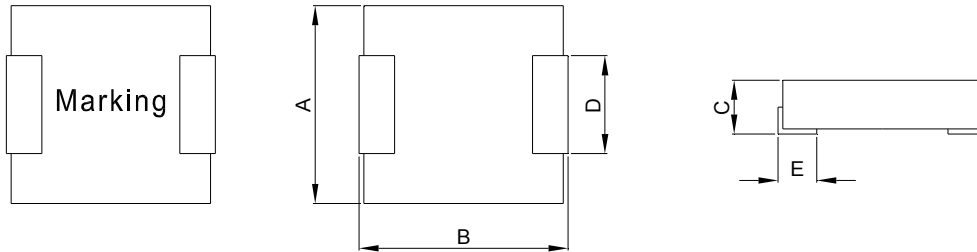

Series	A	B	C	D	E
LML0420AA	4.1±0.2	4.6±0.2	2.0 Max.	1.5±0.3	1.0±0.5
LML0530AA	5.2±0.2	5.4±0.3	2.8±0.2	2.2±0.3	1.2±0.2
LML0612AA	6.6±0.2	7.1±0.2	1.0±0.2	2.9±0.1	1.8±0.3
LML0618AA	6.6±0.2	7.1±0.3	1.6±0.2	3.0±0.3	1.6±0.5
LML0624AA	6.6±0.2	7.1±0.3	2.4 Max.	3.0±0.3	1.6±0.5
LML0630AA	6.6±0.2	7.1±0.3	3.0 Max.	3.0±0.3	1.6±0.5

Electrical Characteristics

LML0420AA Series						
P/N	Inductance (μ H)	Test Freq. (MHz)	Tolerance (\pm %)	DCR (m Ω) \pm 30%	Isat (Max)	Idc (Max)
LML0420AA-R10MR-02	0.10	100	20	4.0	27.0	13.0
LML0420AA-R22MR-02	0.22	100	20	6.6	21.0	9.5
LML0420AA-R47MR-02	0.47	100	20	14.0	11.0	7.5
LML0420AA-R56MR-02	0.56	100	20	16.0	11.0	7.0
LML0420AA-R68MR-02	0.68	100	20	18.0	8.6	7.0
LML0420AA-1R0MR-02	1.0	100	20	27.0	7.0	4.5
LML0420AA-1R2MR-02	1.2	100	20	27.0	6.5	4.5
LML0420AA-1R5MR-02	1.5	100	20	46.0	6.0	4.0
LML0420AA-2R2MR-02	2.2	100	20	58.0	5.0	3.0
LML0420AA-3R3MR-02	3.3	100	20	87.0	4.0	2.5
LML0420AA-4R7MR-02	4.7	100	20	105.0	3.0	2.2
LML0420AA-6R8MR-02	6.8	100	20	135.0	3.0	2.0
LML0420AA-100MR-02	10	100	20	258.0	2.0	1.6



Molding Power Inductors

LML0530AA Series						
P/N	Inductance (μ H)	Test Freq. (MHz)	Tolerance (\pm %)	DCR (m Ω) \pm 30%	Isat (Max)	Idc (Max)
LML0530AA-R20MR-02	0.20	100	20	3.9	17.0	14.0
LML0530AA-R47MR-02	0.47	100	20	8.0	15.0	11.0
LML0530AA-R68MR-02	0.68	100	20	12.0	13.0	9.0
LML0530AA-1R0MR-02	1.0	100	20	14.0	11.0	8.1
LML0530AA-1R2MR-02	1.2	100	20	16.0	11.0	8.1
LML0530AA-1R5MR-02	1.5	100	20	25.0	10.0	7.2
LML0530AA-2R2MR-02	2.2	100	20	29.0	7.5	5.5
LML0530AA-3R3MR-02	3.3	100	20	38.0	6.0	4.8
LML0530AA-4R7MR-02	4.7	100	20	60.0	5.0	4.5
LML0530AA-6R8MR-02	6.8	100	20	90.0	4.0	3.5
LML0530AA-100MR-02	10	100	20	125.0	3.5	2.5

LML0612AA Series						
P/N	Inductance (μ H)	Test Freq. (KHz)	Tolerance (+/-%)	DCR (m Ω) Max.	Isat (Typ.)	Idc (Typ.)
LML0612AA-R56MR-02	0.56	100	20	15.5	11.0	8.0
LML0612AA-R68MR-02	0.68	100	20	17.5	9.5	7.0
LML0612AA-1R0MR-02	1.0	100	20	29.0	7.5	6.0
LML0612AA-2R2MR-02	2.2	100	20	58.0	5.0	4.0
LML0612AA-3R3MR-02	3.3	100	20	92.0	4.0	3.5
LML0612AA-4R7MR-02	4.7	100	20	122.0	3.5	2.8
LML0612AA-6R8MR-02	6.8	100	20	210.0	2.8	2.1
LML0612AA-100MR-02	10	100	20	280.0	2.2	2.0

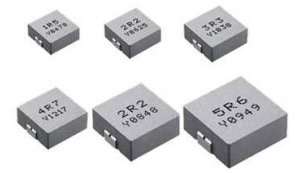

Molding Power Inductors

LML0618AA Series						
P/N	Inductance (uH)	Test Freq. (KHz)	Tolerance (+/-%)	DCR (mΩ) Max.	Isat (Typ.)	Idc (Typ.)
LML0618AA-R68MR-02	0.68	100	20	12.7	17.0	9.0
LML0618AA-1R0MR-02	1.0	100	20	17.0	14.0	7.0
LML0618AA-1R5MR-02	1.5	100	20	26.0	12.0	6.5
LML0618AA-2R2MR-02	2.2	100	20	35.0	8.0	5.0
LML0618AA-3R3MR-02	3.3	100	20	60.0	8.0	3.5
LML0618AA-4R7MR-02	4.7	100	20	70.0	5.0	3.5
LML0618AA-6R8MR-02	6.8	100	20	110.0	4.5	2.8
LML0618AA-100MR-02	10	100	20	155.0	2.5	2.3

LML0624AA Series						
P/N	Inductance (uH)	Test Freq. (KHz)	Tolerance (+/-%)	DCR (mΩ) Max.	Isat (Typ.)	Idc (Typ.)
LML0624AA-R22MR-02	0.22	100	20	3.0	34.0	21.0
LML0624AA-R33MR-02	0.33	100	20	4.1	26.0	18.0
LML0624AA-R47MR-02	0.47	100	20	5.1	22.0	15.0
LML0624AA-R56MR-02	0.56	100	20	6.5	17.0	13.0
LML0624AA-R68MR-02	0.68	100	20	7.0	16.0	12.0
LML0624AA-1R0MR-02	1.0	100	20	13.5	16.0	9.0
LML0624AA-1R5MR-02	1.5	100	20	20.0	15.0	9.0
LML0624AA-2R2MR-02	2.2	100	20	28.0	12.0	7.0
LML0624AA-3R3MR-02	3.3	100	20	39.0	10.0	5.5
LML0624AA-4R7MR-02	4.7	100	20	50.0	7.5	5.0
LML0624AA-6R8MR-02	6.8	100	20	65.0	6.0	4.0
LML0624AA-100MR-02	10	100	20	101.0	5.0	3.1

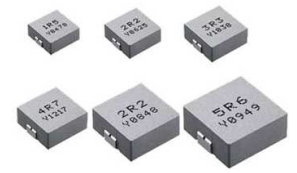

Molding Power Inductors

LML0630AA Series						
P/N	Inductance (uH)	Test Freq. (KHz)	Tolerance (+/-%)	DCR (mΩ) Max.	Isat (Typ.)	Idc (Typ.)
LML0630AA-R22MR-02	0.22	100	20	3.0	42.0	24.0
LML0630AA-R24MR-02	0.24	100	20	3.1	31.0	23.0
LML0630AA-R33MR-02	0.33	100	20	3.5	30.0	21.0
LML0630AA-R47MR-02	0.47	100	20	4.1	20.0	18.0
LML0630AA-R56MR-02	0.56	100	20	4.5	18.0	16.5
LML0630AA-R68MR-02	0.68	100	20	5.3	17.0	16.0
LML0630AA-R82MR-02	0.82	100	20	6.0	17.0	14.0
LML0630AA-1R0MR-02	1.0	100	20	7.4	15.0	12.0
LML0630AA-1R5MR-02	1.5	100	20	12.1	14.0	10.0
LML0630AA-2R2MR-02	2.2	100	20	15.0	10.0	8.0
LML0630AA-3R3MR-02	3.3	100	20	22.0	9.5	6.5
LML0630AA-4R7MR-02	4.7	100	20	33.0	6.5	5.5
LML0630AA-6R8MR-02	6.8	100	20	50.0	6.0	4.5
LML0630AA-8R2MR-02	8.2	100	20	60.0	6.0	4.2
LML0630AA-100MR-02	10.	100	20	68.0	5.5	4.0
LML0630AA-150MR-02	15.	100	20	115.0	4.5	3.0
LML0630AA-220MR-02	22.	100	20	200.0	3.0	2.3
LML0630AA-330MR-02	33.	100	20	310.0	3.0	2.0

NOTE :

- ◎Testing frequency:100KHz/1V
- ◎All test Data is referenced to 20°C ambient
- ◎Typical Heat Rating DC Current (Idc) would cause an approximately ΔT of 40°C
- ◎Typical Saturation DC Current (Isat) would cause open load inductance to drop approximately 30%