



STGW30NC120HD Alternative

N-CHANNEL 1200V Trench and Fieldstop IGBT



Part Number: JAD112MI40

PRODUCT SUMMARY		
V_{CE} (V)	1200	
I_C (A)	80 (TC=25°C)	40 (TC=100°C)
$V_{CE(sat)}$ (V)	1.8	
I_{CM} (A)	120	

FEATURES

- Very Low V_{CEsat}
- Low turn-off losses
- High speed switching
- Maximum junction temperature 175°C
- Ultra low gate charge (Q_g)
- Avalanche energy rated (UIS)



RoHS
COMPLIANT
HALOGEN
FREE

APPLICATIONS

- Telecommunications
 - Server and telecom power supplies
- Lighting
 - High-intensity discharge (HID)
 - Fluorescent ballast lighting
- Consumer and computing
 - ATX power supplies
- Industrial
 - Welding
 - Battery chargers
- Renewable energy
 - Solar (PV inverters)
- Switch mode power supplies (SMPS)

TO-247

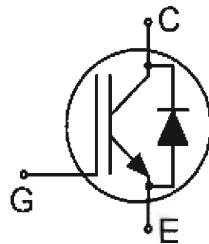

Package pin definition

- Pin1 G - Gate
- Pin2 C & backside - Collector
- Pin3 E - Emitter

ABSOLUTE MAXIMUM RATINGS ($T_C = 25^\circ\text{C}$, unless otherwise noted)			
PARAMETER	SYMBOL	LIMIT	UNIT
Collector-Emitter Voltage	V_{CE}	1200	V
Gate-Emitter Voltage	V_{GE}	± 30	
Continuous Collector Current ($T_J = 150^\circ\text{C}$)	V_{GE} at 15 V	$T_C = 25^\circ\text{C}$	A
		$T_C = 100^\circ\text{C}$	
Pulsed Collector Current ^a	I_{CM}	120	
Diode Forward Current ^b	I_F	40	A
Maximum Power Dissipation		$T_C = 25^\circ\text{C}$	W
		$T_C = 100^\circ\text{C}$	W
Operating Junction and Storage Temperature Range	T_J, T_{stg}	-55 to +175	°C
Short Circuit Withstand Time $T_C=150^\circ\text{C}$	$V_{GE} = 15\text{V}, V_{CE} \leq 400\text{V}$		μs
Short Circuit Withstand Time $T_C=100^\circ\text{C}$			
Soldering Recommendations (Peak Temperature) ^c	for 10 s	260	°C

Notes

- Repetitive rating; pulse width limited by maximum junction temperature.
- Current limited by maximum junction temperature.
- 1.6 mm from case.



STGW30NC120HD Alternative

N-CHANNEL 1200V Trench and Fieldstop IGBT



Part Number: JAD112MI40

THERMAL RESISTANCE RATINGS				
PARAMETER	SYMBOL	TYP.	MAX.	UNIT
Maximum Junction-to-Ambient	R_{thJA}	-	40	°C/W
Maximum Junction-to-Case	R_{thJC}	-	0.5	

SPECIFICATIONS ($T_J = 25\text{ °C}$, unless otherwise noted)							
PARAMETER	SYMBOL	TEST CONDITIONS		MIN.	TYP.	MAX.	UNIT
Static							
Collector-Emitter Breakdown Voltage	BV_{CE}	$V_{GE} = 0\text{ V}, I_C = 250\text{ }\mu\text{A}$ $V_{GE} = 0\text{ V}, I_C = 1\text{ mA}$		1200 1200	- -	- -	V
Gate-Source Threshold Voltage (N)	$V_{GE(th)}$	$V_{CE} = V_{GE}, I_D = 250\text{ }\mu\text{A}$		4	5	6	V
Zero Gate Voltage Collector Current	I_{CES}	$V_{CE} = 1200\text{ V}, V_{GE} = 0\text{ V}, T_J = 25\text{ °C}$		-	1	20	μA
		$V_{CE} = 1200\text{ V}, V_{GE} = 0\text{ V}, T_J = 150\text{ °C}$		-	1000	-	μA
Gate-Emitter Leakage Current	I_{GES}	$V_{CE} = 0\text{ V}, V_{GS} = \pm 20\text{ V}$		-	-	100	nA
Collector-Emitter Saturation Voltage	$V_{CE(sat)}$	$V_{GE} = 15\text{ V}$	$I_C = 40\text{ A}$	-	1.7	2.1	V
Forward Transconductance	g_{fs}	$V_{CE} = 20\text{ V}, I_C = 40\text{ A}$		-	40	-	S
Dynamic							
Input Capacitance	C_{ies}	$V_{GE} = 0\text{ V}, V_{CE} = 25\text{ V},$ $f = 500\text{ KHz}$		-	4300	-	pF
Output Capacitance	C_{oes}			-	230	-	
Reverse Transfer Capacitance	C_{res}			-	68	-	
Turn-on Energy	E_{on}	$V_{CE} = 400\text{ V}, V_{GE} = 0/15\text{V},$ $I_C = 40\text{ A}, R_g = 10\Omega$		-	0.4	-	nJ
Turn-off Energy	E_{off}			-	0.5	-	
Total Gate Charge	Q_g	$V_{GE} = 15\text{ V}$	$I_C = 40\text{ A}, V_{CE} = 400\text{ V}$	-	178	-	nC
Gate-Emitter Charge	Q_{ge}			-	16	-	
Gate to Collector Charge	Q_{gc}			-	42	-	
Turn-On Delay Time	$t_{d(on)}$	$V_{CE} = 400\text{ V}, V_{GE} = 0/15\text{V},$ $I_C = 40\text{ A}, R_g = 10\Omega$		-	68	-	ns
Rise Time	t_r			-	52	-	
Turn-Off Delay Time	$t_{d(off)}$			-	178	-	
Fall Time	t_f			-	32	-	
Internal emitter inductance measured 5 mm	L_E			-	13	-	nH
Diode Characteristics							
Diode Forward Current	I_F	IGBT symbol showing the integral reverse junction diode		-	-	40	A
Pulsed Diode Forward Current	I_{FM}			-	-	120	
Diode Forward Voltage	V_F	$I_F = 40\text{ A}$		-	1.73	2.0	V
Reverse Recovery Time	t_{rr}	$T_J = 25\text{ °C}, I_F = 40\text{ A},$ $dI_F/dt = 200\text{ A}/\mu\text{s}, V_R = 400\text{ V}$		-	82	-	ns
Reverse Recovery Charge	Q_{rr}			-	0.24	-	μC
Reverse Recovery Current	I_{RRM}			-	14	-	A



STGW30NC120HD Alternative

Part Number: JAD112MI40

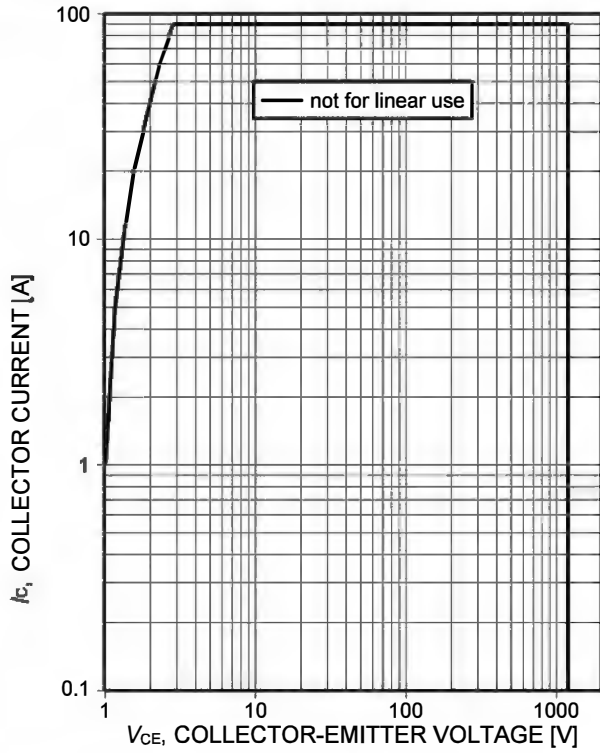

Figure 1. Forward bias safe operating area

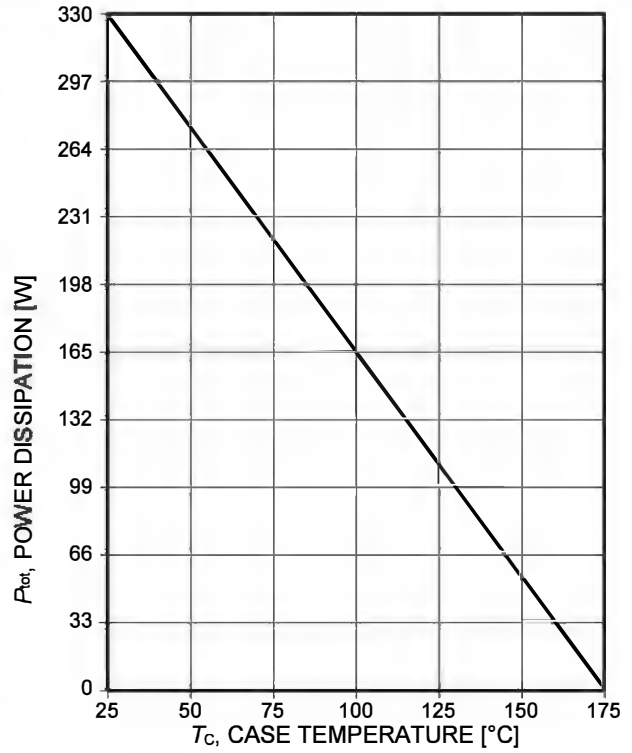

Figure 2. Power dissipation as a function of case temperature

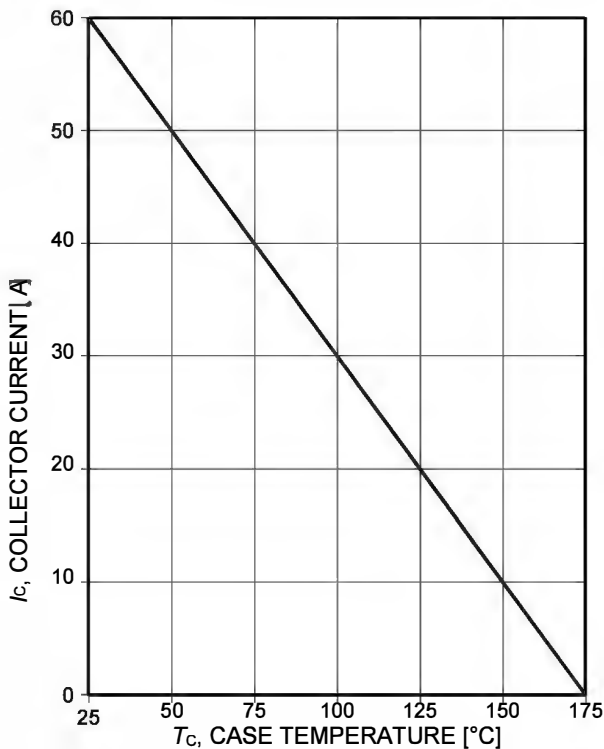

Figure 3. Collector current as a function of case temperature

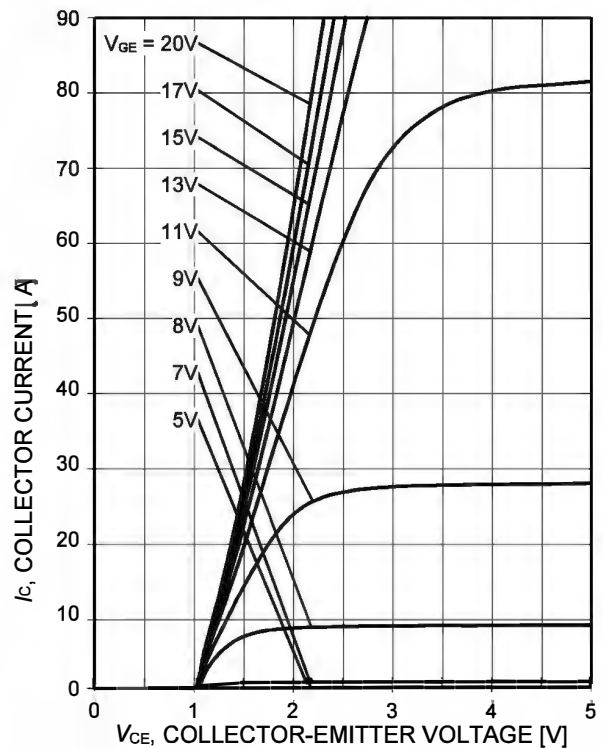

Figure 4. Typical output characteristic

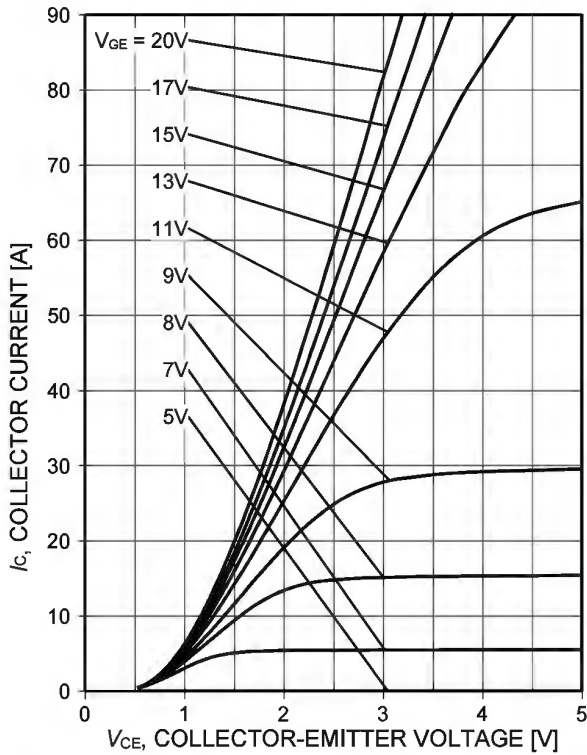

Figure 5. Typical output characteristic

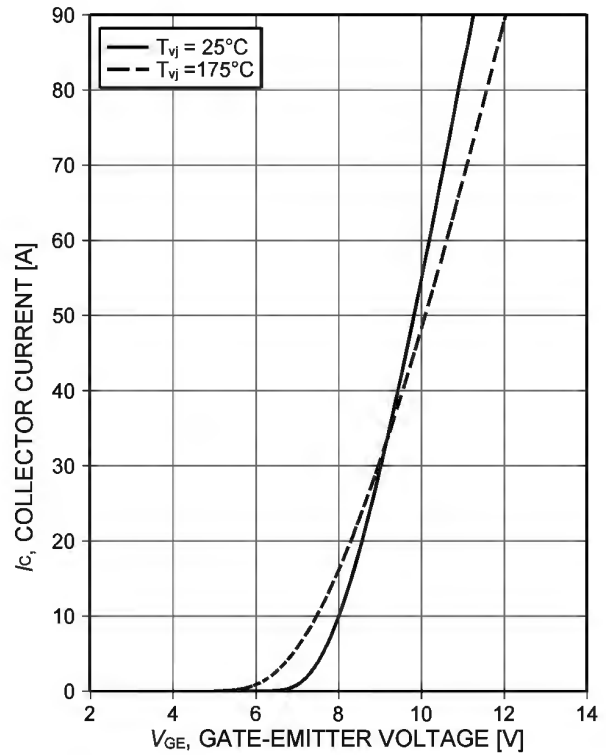

Figure 6. Typical transfer characteristic

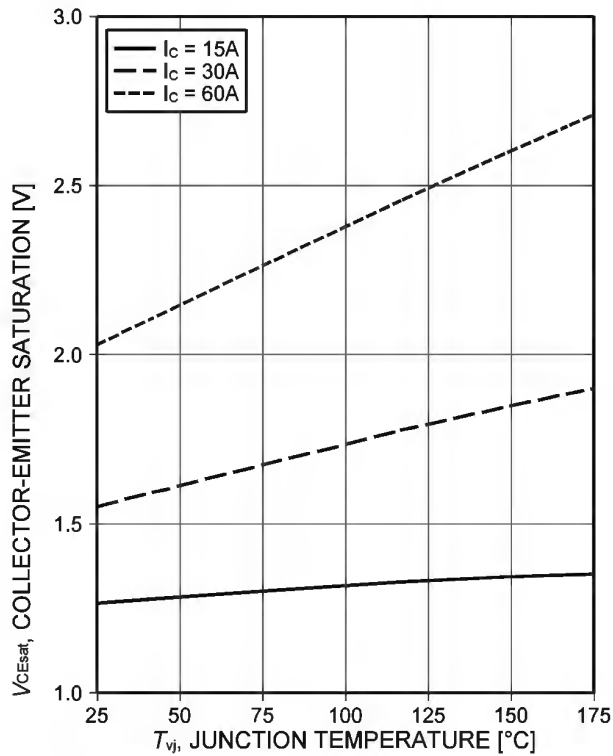

Figure 7. Typical collector-emitter saturation voltage as a function of junction temperature

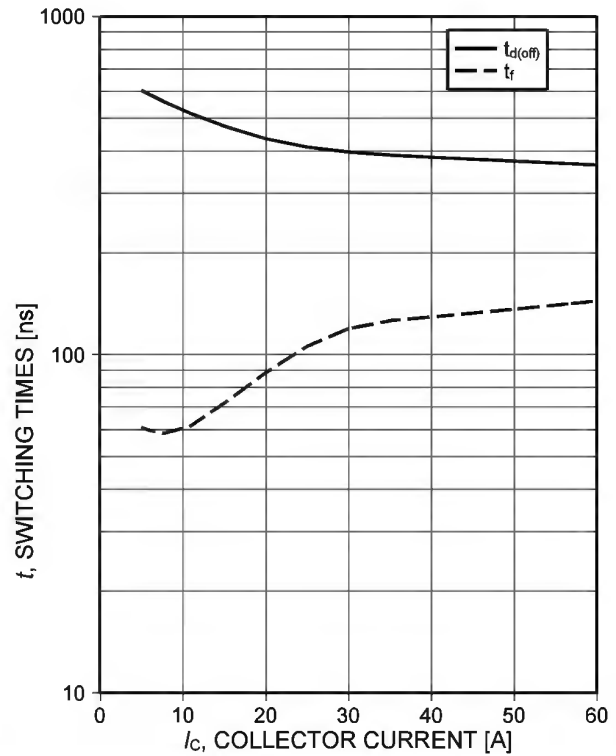

Figure 8. Typical switching times as a function of collector current

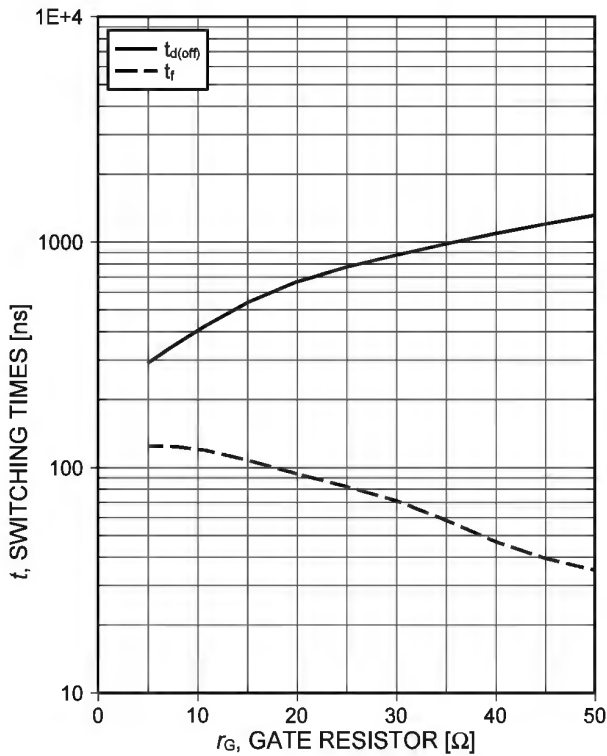

Figure 9. Typical switching times as a function of gate resistor

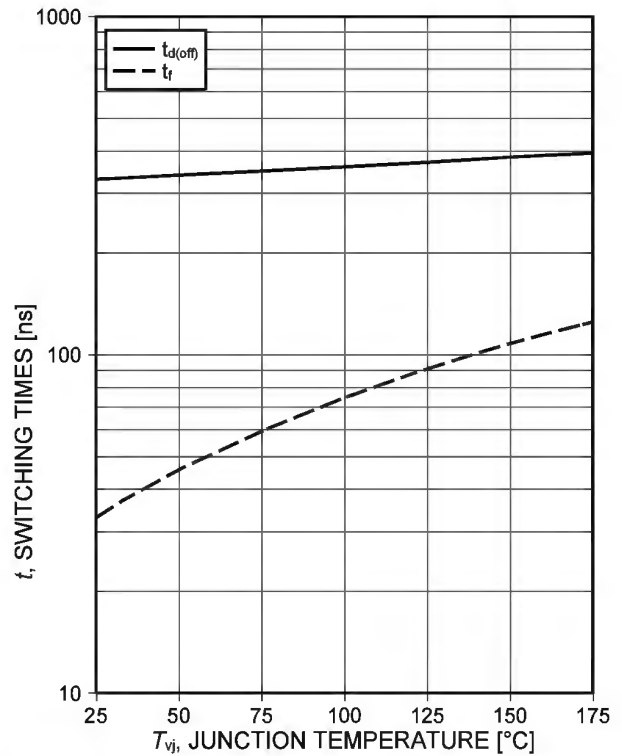

Figure 10. Typical switching times as a function of junction temperature

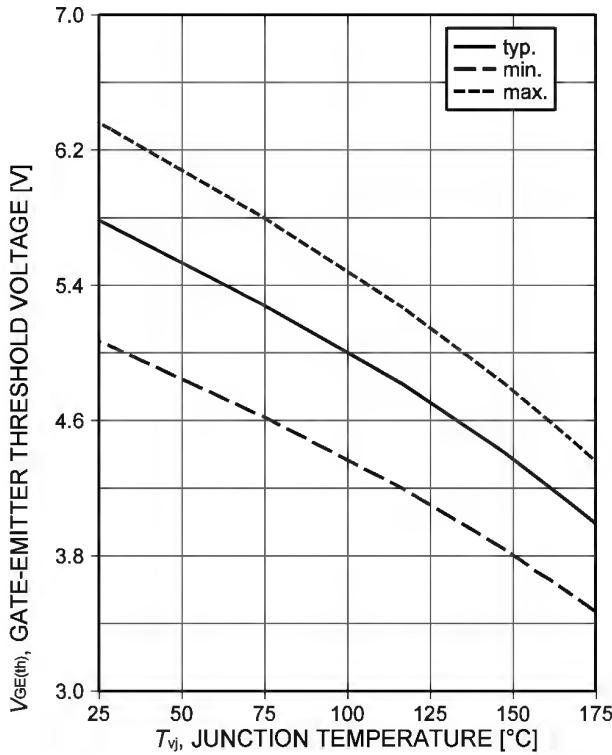

Figure 11. Gate-emitter threshold voltage as a function of junction temperature

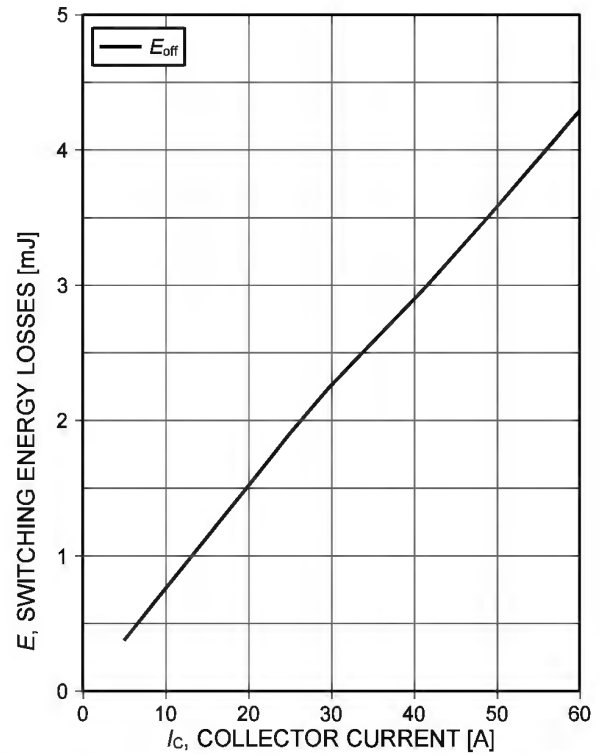

Figure 12. Typical switching energy losses as a function of collector current

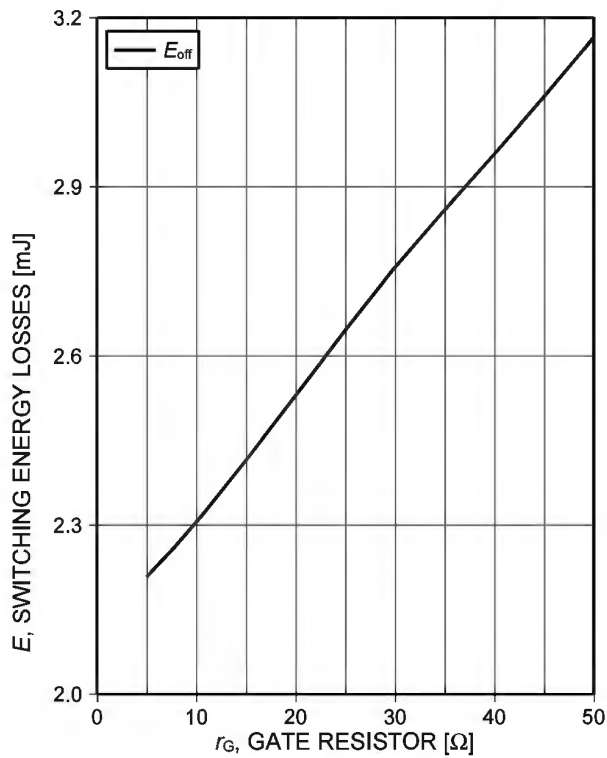

Figure 13. Typical switching energy losses as a function of gate resistor

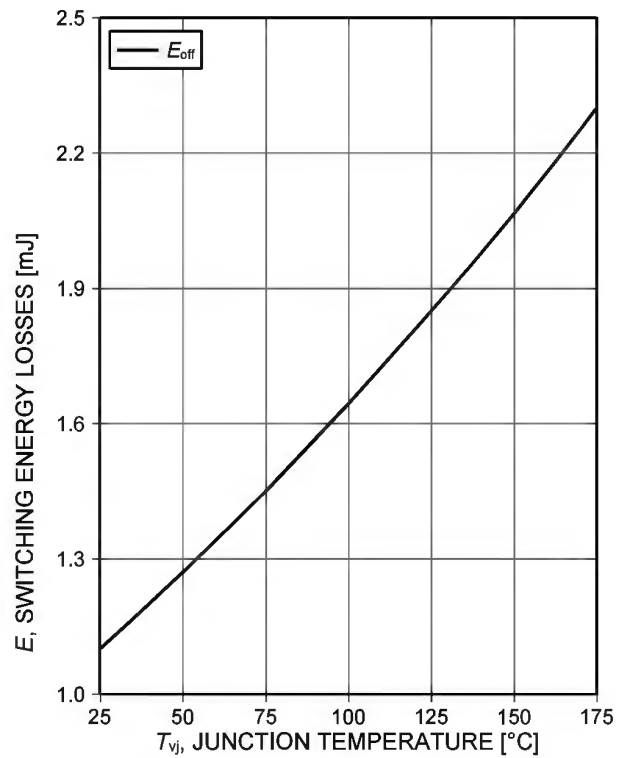

Figure 14. Typical switching energy losses as a function of junction temperature

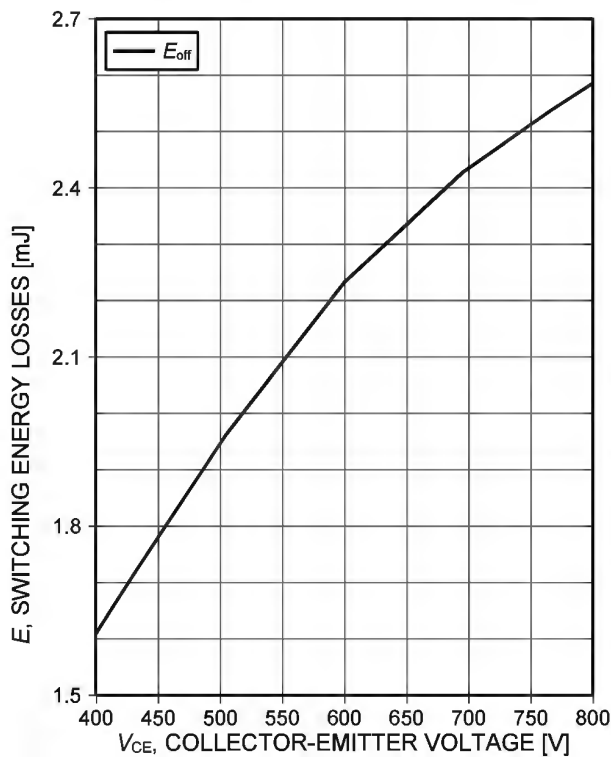

Figure 15. Typical switching energy losses as a function of collector emitter voltage

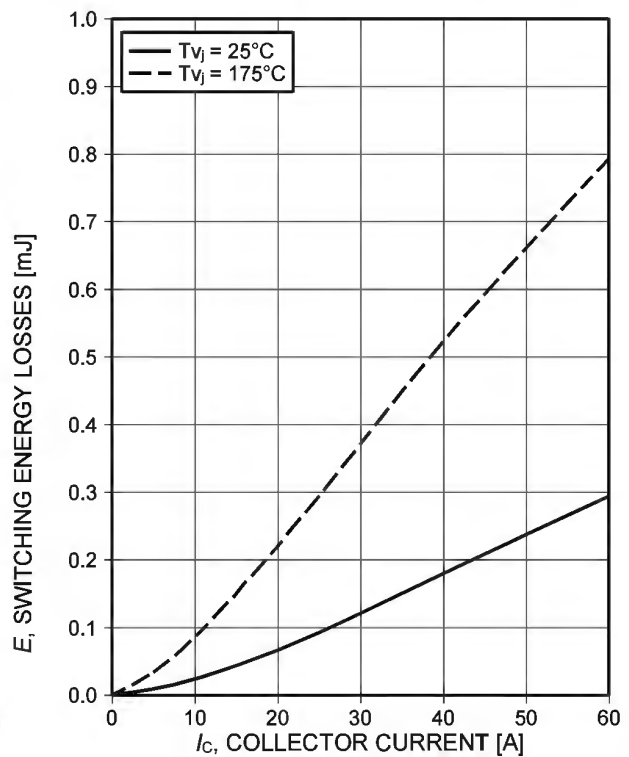

Figure 16. Typical turn off switching energy loss for soft switching

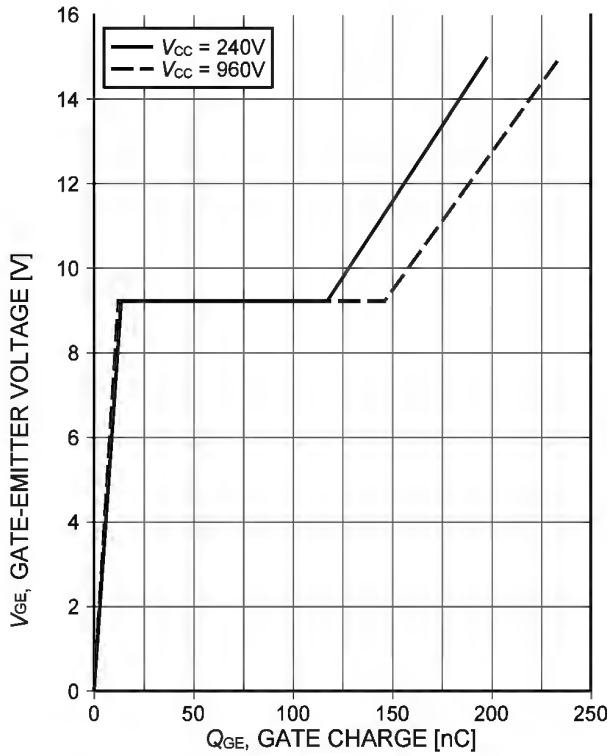

Figure 17. Typical gate charge

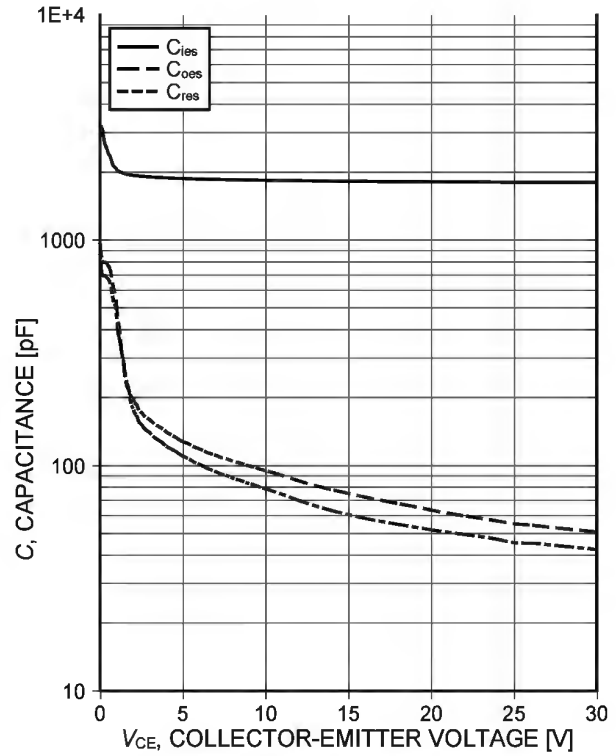

Figure 18. Typical capacitance as a function of collector-emitter voltage

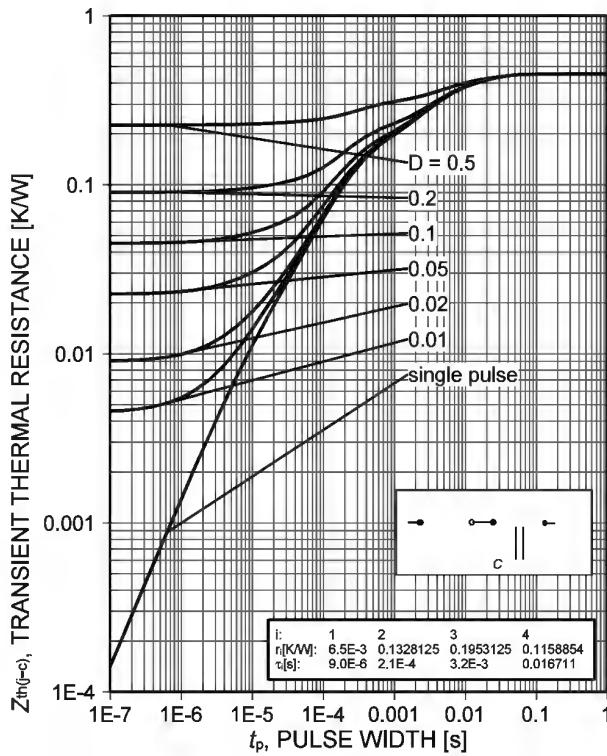

Figure 19. IGBT transient thermal resistance

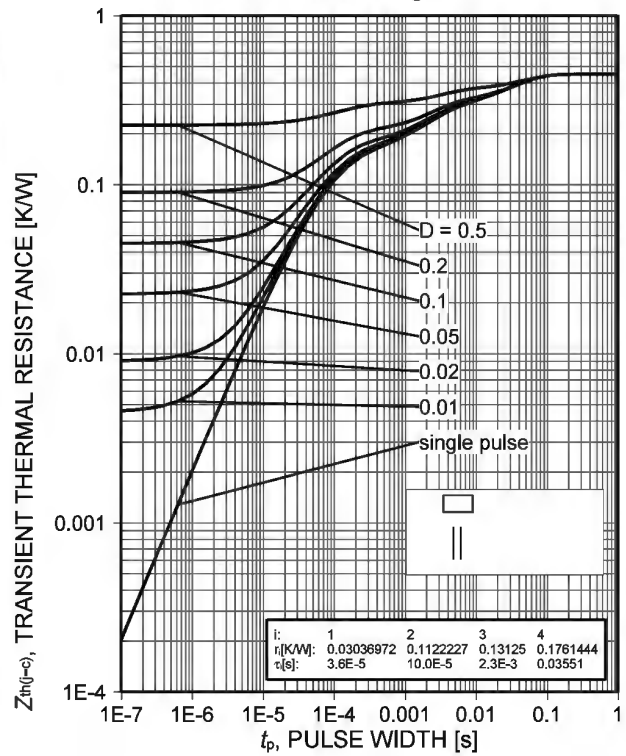

Figure 20. Diode transient thermal impedance as a function of pulse width



STGW30NC120HD Alternative

N-CHANNEL 1200V Trench and Fieldstop IGBT



Part Number: JAD112MI40

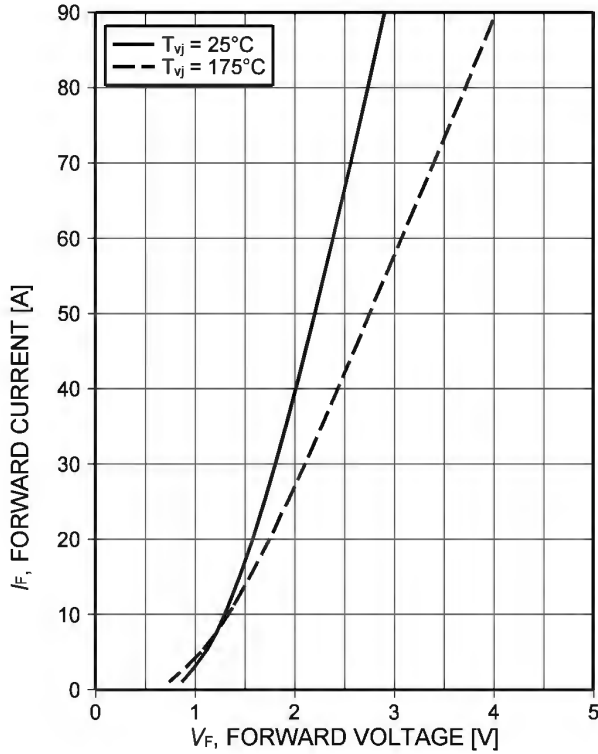

Figure 21. Typical diode forward current as a function of forward voltage

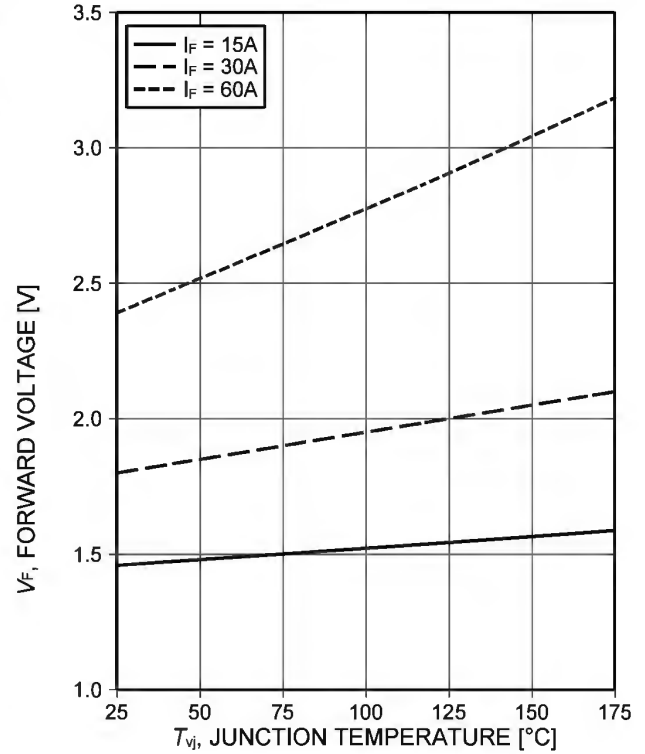

Figure 22. Typical diode forward voltage as a function of junction temperature



STGW30NC120HD Alternative

Part Number: JAD112MI40



Package: TO-247

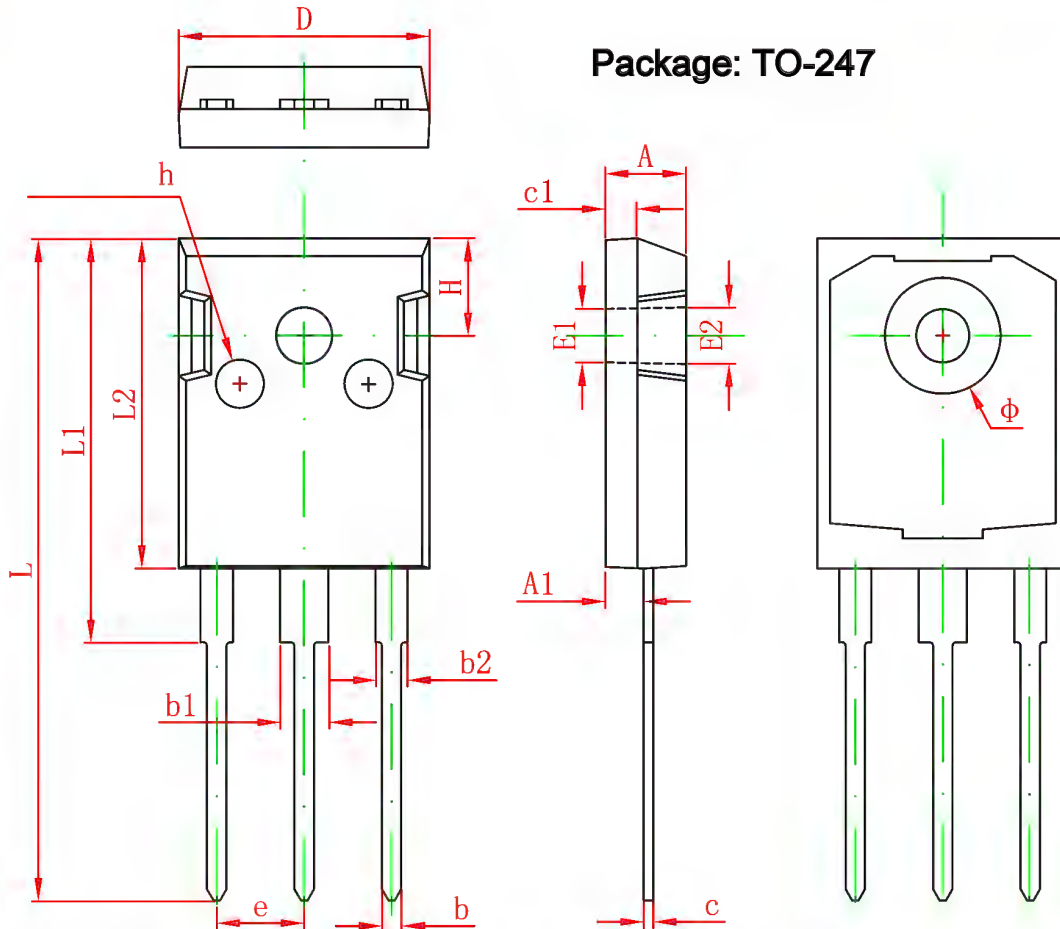

Symbol	Dimensions In Millimeters		Dimensions In Inches	
	Min	Max	Min	Max
A	4.850	5.150	0.191	0.200
A1	2.200	2.600	0.087	0.102
b	1.000	1.400	0.039	0.055
b1	2.800	3.200	0.110	0.126
b2	1.800	2.200	0.071	0.087
c	0.500	0.700	0.020	0.028
c1	1.900	2.100	0.075	0.083
D	15.450	15.750	0.608	0.620
E1	3.500 REF		0.138 REF	
E2	3.600 REF		0.142 REF	
L	40.900	41.300	1.610	1.626
L1	24.800	25.100	0.976	0.988
L2	20.300	20.600	0.799	0.811
φ	7.100	7.300	0.280	0.287
e	5.450 TYP		0.215 TYP	
H	5.980 REF		0.235 REF	
h	0.000	0.300	0.000	0.012

Disclaimer

All products due to improve reliability, function or design or for other reasons, product specifications and data are subject to change without notice.

BEC Distribution Limited, branches, agents, employees, and all persons acting on its or their representatives (collectively, BEC Distribution Limited"), assumes no responsibility for any errors, inaccuracies or incomplete data contained in the table or any other any disclosure of any information related to the product.(www.bec.co.uk)

BEC Distribution Limited makes no guarantee, representation or warranty on the product for any particular purpose of any goods or continuous production. To the maximum extent permitted by applicable law on BEC Distribution Limited relinquished: (1) any application and all liability arising out of or use of any products; (2) any and all liability, including but not limited to special, consequential damages or incidental ; (3) any and all implied warranties, including a particular purpose, non-infringement and merchantability guarantee.

Statement on certain types of applications are based on knowledge of the product is often used in a typical application of the general product BEC Distribution Limited demand that the BEC Distribution Limited Statement on whether the product is suitable for a particular application is non-binding. It is the customer's responsibility to verify specific product features in the products described in the specification is appropriate for use in a particular application. Parameter data sheets and technical specifications can be provided may vary depending on the application and performance over time. All operating parameters, including typical parameters must be made by customer's technical experts validated for each customer application. Product specifications do not expand or modify BEC Distribution Limited purchasing terms and conditions, including but not limited to warranty herein.

Unless expressly stated in writing, BEC Distribution Limited products are not intended for use in medical, life saving, or life sustaining applications or any other application. Wherein BEC Distribution product failure could lead to personal injury or death, use or sale of products used in BEC Distribution Limited such applications using client did not express their own risk. Contact BEC Distribution Limited who are related to product design applications and other terms and conditions in writing.

The information provided in this document and the company's products without a license, express or implied, by estoppel or otherwise, to any intellectual property rights granted to the BEC Distribution Limited act or document. Product names and trademarks referred to herein are trademarks of their respective representatives will be all.

Material Category Policy

BEC Distribution Limited, hereby certify that all of the products are determined to be RoHS compliant and meets the definition of restrictions under Directive of the European Parliament 2011/65 / EU, 2011 Nian. 6. 8 Ri Yue restrict the use of certain hazardous substances in electrical and electronic equipment (EEE) - modification, unless otherwise specified as inconsistent.(www.bec.co.uk)

Please note that some documents may still refer to BEC Distribution Limited RoHS Directive 2002/95 / EC. We confirm that all products identified as consistent with the Directive 2002/95 / EC European Directive 2011/65 /.

BEC Distribution Limited hereby certify that all of its products comply identified as halogen-free halogen-free standards required by the JEDEC JS709A. Please note that some BEC Distribution documents still refer to the definition of IEC 61249-2-21, and we are sure that all products conform to confirm compliance with IEC 61249-2-21 standard level JS709A.